



# Sentinel-1

Ref: S1-RS-MDA-52-7441  
MPC Nom: DI-MPC-PB  
MPC Ref: MPC-0240  
Issue/Revision: 3/12  
Date: 19/09/2022

## Sentinel-1 Product Specification

Prepared By: Guillaume Hajduch, M. Bourbigot

Harald Johnsen, Riccardo Piantanida

Checked By: Guillaume Hajduch

Quality Assurance: Julie Poullaouec

Project Manager: Guillaume Hajduch

(signature / date)

**Document Number: S1-RS-MDA-52-7441**  
**S-1 MPC Nomenclature: DI-MPC-PB**  
**S-1 MPC Reference: MPC-0240**



# Sentinel-1

Ref: S1-RS-MDA-52-7441  
MPC Nom: DI-MPC-PB  
MPC Ref: MPC-0240  
Issue/Revision: 3/12  
Date: 19/09/2022

## CHANGE RECORD

From issue 1.0 to 2.9, the Sentinel-1 Product Specification was maintained by a consortium led by MDA under the reference S1-RS-MDA-52-7441.

The S-1 IPF and associated documentation is then maintained by the S-1 Mission Performance Centre. From the issue 3.0 the Sentinel-1 Product Specification is maintained by the S-1 Mission Performance Center which is a consortium led by CLS.

ISSUE	DATE	PAGE(S)	DESCRIPTION
1/0	June 26, 2009	All	First Issue
2/0	July 30, 2010	All	Second Issue Added Level 2 Product Specification for PDR L2. Updated based on content of CCN N.2 Addressed PDR L1 RIDs (High): RID 2: Re-organized the layout of Appendix A. RID 10(1): Clarified the text introducing the ADSR Summary table. RID 10(3): Added a column with references to applicable appendix for ADSR summary table. RID 11: Relocated and updated naming template. RID 15: Updated naming convention and inclusion criteria for Quick-look MDS. RID 16: Added more detailed descriptions of the manifest file to the Product Format Overview and Product Data Sets sections. RID 18: Updated definition of ModelTiePointTag to include all tie points in an image. RID 19: The azimuthSteeringRate has been placed in the productInformation record. Addressed PDR L1 RIDs (Med/Low): RID 1, RID 3, RID 4, RID 6, RID 7, RID 8, RID 9, RID 12, RID 13, RID 14, RID 17, RID 20, RID 21, RID 22, RID 24, RID 25, RID 26, RID 27, RID 28

ISSUE	DATE	PAGE(S)	DESCRIPTION
2/1	Nov. 1, 2010	All	<p>Second Issue, First Revision</p> <p>Addressed Major Delta PDR L1/PDR L2 RIDs:</p> <p>S1IPFPDR-137: Added formulae describing how to use the absolute calibration LUTs.</p> <p>S1IPFPDR-138: Enhanced description of noise LUT and added formulae describing how to use it.</p> <p>S1IPFPDR-207: Updated S1 Internal Calibration annotations.</p> <p>S1IPFPDR-209: Update swath merging annotations structure and description.</p> <p>S1IPFPDR-210: Noise LUT reduced to a single vector.</p> <p>S1IPFPDR-217, S1IPFPDR-279, and S1IPFPDR-283: Updated slicing-related content and descriptions of assembled products.</p> <p>S1IPFPDR-314: Updated description of issue relating to assembly of TOPS SLC QL.</p> <p>Addressed Minor Delta PDR L1/PDR L2 RIDs:</p> <p>S1IPFPDR-139, S1IPFPDR-140, S1IPFPDR-141, S1IPFPDR-142, S1IPFPDR-143, S1IPFPDR-144, S1IPFPDR-146, S1IPFPDR-147, S1IPFPDR-149, S1IPFPDR-191, S1IPFPDR-193, S1IPFPDR-194, S1IPFPDR-196, S1IPFPDR-199, S1IPFPDR-206, S1IPFPDR-208, S1IPFPDR-284, S1IPFPDR-286, S1IPFPDR-291, S1IPFPDR-292, S1IPFPDR-296, S1IPFPDR-297, S1IPFPDR-298, S1IPFPDR-299, S1IPFPDR-312, S1IPFPDR-313, S1IPFPDR-315, S1IPFPDR-316</p>
2/2	May 6, 2011	All	<p>Second Issue, Second Revision</p> <p>Addressed Minor PDR L2 RIDs:</p> <p>S1IPFPDR-148, PDRL2-A8</p> <p>Addressed Minor Delta PDR L2 RIDs:</p> <p>S1IPFDPDRL2-46, S1IPFDPDRL2-47, S1IPFDPDRL2-48 (partially addressed, TBC is still to be resolved), S1IPFDPDRL2-50, S1IPFDPDRL2-51, S1IPFDPDRL2-52</p> <p>The following RIDs were raised but no updates to this document were required:</p> <p>S1IPFDPDRL2-31, S1IPFDPDRL2-49</p>

ISSUE	DATE	PAGE(S)	DESCRIPTION
2/3	Sept. 22, 2011		Second Issue, Third Revision
			Addressed Major CDR L1&L2 RIDs:
		Section 6.3	IPFCDR-123: The description for the <code>downlinkInformationType</code> was updated to describe the fact that the record contains records for multiple swaths in the IW/EW GRD case. Other similar field descriptions also updated.
		Section 6.1.2	IPFCDR-133: An optional <code>leapSecondInformation</code> section has been added to the manifest metadata, matching the definition in the L0 specification.
		Section 6.1	IPFCDR-132 and IPFCDR-134: Added Table 6-2 to describe data types used within the manifest, and updated Table 6-6 to align with Table 6-2 and improve wrapped metadata descriptions.
		Section 6.3.5	IPFCDR-137: Updated the product preview example to use a preview from a product generated by the IPF.
			Addressed Minor CDR L1&L2 RIDs:
		All	IPFCDR-20, IPFCDR-96, IPFCDR-97, IPFCDR-114, IPFCDR-115, IPFCDR-116, IPFCDR-117, IPFCDR-119, IPFCDR-120, IPFCDR-124, IPFCDR-129, IPFCDR-130, IPFCDR-131, IPFCDR-135, IPFCDR-136
2/4	May 01, 2012		Second Issue, Fourth Revision
		Section 3.4	Updated slicing section for changes in annotations.
		Table 3-19	Added <code>sensorModeType</code> , <code>floatCoefficientArray</code> and <code>doubleCoefficientArray</code> types, and modified supported ranges for primitive data types
		Table 3-20	Added mode to <code>adsHeaderType</code> .
		Table 6-7	Updates to manifest field descriptions.
		Section 6.2.3	Updated field names for L2 OCN to distinguish between the three different components and removed <code>contactInformation</code> field.

ISSUE	DATE	PAGE(S)	DESCRIPTION
		Section 6.3.1.1	CDR-A14: Updated missing line/gap fields to distinguish between downlink and instrument missing lines.  Updated replica/PG quality fields.  Updated DC quality fields to change SNR to RMS error.  Updated description of productQualityIndex: Reserved for future use as agreed at the FAT.
		Section 6.3.1.2	Minor updates to general annotation DSR field descriptions, added timeDelay and gain fields to replica.
		Section 6.3.1.3	Updated slice parameters.  Renamed numberOfRangeSamples to numberOfSamples and numberOfAzimuthLines to numberOfLines.  Added pgSource.  Added correctBistaticDelayFlag.  Added processorScalingFactor.
		Section 6.3.1.4	Modified DCE fields to use RMS error instead of SNR.
		Section 6.3.1.6	Added sensingTime to swath timing structure.
		Section 6.3.2	Updated the calibration vector description and conversion formulae. Removed processorScalingFactor and offset fields.
		Section 6.3.3	Updated the noise vector formulae.
2/5	Aug. 27, 2012		Second Issue, Fifth Revision
		Section 6.2.3	Updated L2 structures.
		Table 6-67	Renamed correctBistaticDelayFlag to bistaticDelayCorrectionApplied
		Table 3-8, 6-11	Removed Copyright field from GeoTIFF metadata.
		Table 6-7	Updated platform->instrument wrapped metadata: added swath field and corrected the description of the swathNumber field.

ISSUE	DATE	PAGE(S)	DESCRIPTION
2/6	Feb. 18, 2013		Second Issue, Sixth Revision
			Updates for CCN#4:
		Section 3.1	Added descriptions of notch modes.
		Section 3.4	Updated assembly strategies for affected fields.
		Sections 3.5.1, 3.5.3	Added support for notch modes
		Section 3.6.1	Corrected description of the byte order of L1 measurement data.
		Section 3.6.3	Added support for notch modes. Added coordinate system reference frame type. Added type for TOPS filter origin.
		Sections 4.1, 4.2	Added support for notch modes.
		Section 6.1	Updated manifest description
		Section 6.2.3.3	Updated descriptions of owiInversionQuality and owiWindQuality fields.
		Table 6-23	Added missing line counters and flags for SSB Error Flag.
		Table 6-28	Updated the description of orbit and attitude lists.
		Table 6-31	Added prf field to downlinkInformationType
		Table 6-32	Added counter for SSB Error Flag.
		Table 6-43	Added frame field to orbitType.
		Table 6-47	Added frame field to attitudeType.
		Table 6-55	Removed values array from replicaType
		Table 6-63	Added azimuthFrequency to imageInformationType
		Table 6-67	Added rxVariationCorrectionApplied and topsFilterOrigin to processingInformationType.
		Figure 6-16	Update L1 Image ADSR figure.
2/7	Jan. 30, 2014		Second Issue, Seventh Revision
		All	Removed copyright, use and disclosure notice.
		Section 2.1	Removed obsolete document references.
		Section 3.3.5	Clarified that the L0 resources are included in the manifest file.
		Section 3.6.1	Updated SAFE namespaces.

ISSUE	DATE	PAGE(S)	DESCRIPTION
		Table 3-14	S1IPF-93: Clarified that the start and stop times are different for each MDS in a TOPS SLC product.
		Table 3-19	Increased size of floatCoefficientArray and doubleCoefficientArray from 10 to 22  S1IPF-114: Corrected enumeration for orbitAttitudeSourceType.
		Table 4-1	Added note clarifying that the start/stop times differ by swath for TOPS SLC products.
		Table 6-23	S1IPF-93: Corrected case for ssbErrorMissingLinesSignificantFlag.
		Table 6-7	Added and corrected the namespace prefixes for the manifest file elements.  S1IPF-94: Changed cardinality for manifest elements that do not apply to ASAR L2 OCN products generated from ASAR L1 inputs.
		Table 6-52	Updated the description of the referenceReplica and replicaList elements to clarify that the referenceReplica relates to the imaging replica and the replicaList relates to the PG replicas.
		Table 6-53	Changed the type of the timeDelay parameter to float and clarified that the time delay for the reference image replica is set to the average time delay measured from the PG calibration pulses.
		Table 6-54	Updated the description and cardinality of the replica element.
		Table 6-55	Changed the data type of the PG replica parameters from double to float to match the precision used by the IPF.  Clarified the description of the values reported for the pgProductAmplitude and pgProductPhase.
		Table 6-57	Changed the data type of the noisePowerCorrectionFactor from double to float to match the precision used by the IPF.
		Table 6-63	S1IPF-100: Clarified the meaning of the productFirst/LastLineUtcTime fields.
		Table 6-69	Updated the description of the processorScalingFactor and clarified that it is the $k_{proc}$ value defined in the L1 algorithm definition.

ISSUE	DATE	PAGE(S)	DESCRIPTION
2/8	May 30, 2014		Second Issue, Eighth Revision
		Table 3-19	Corrected typo in range of imageNumberType. Corrected range of absOrbitNumberType. Changed range of missionDataTakeIdType from hexadecimal to integer to match the software.
		Table 6-53	Clarified the description of the timeDelay parameter.
		Table 6-55	Clarified the description of the reconstructedReplicaValidFlag. Changed the equations for the values of pgProductAmplitude and pgProductPhase to include the sqrt() function. Clarified the description of the internalTimeDelay parameter.
2/9	Nov. 21, 2014		Second Issue, Ninth Revision
		Section 3.4.1.3	Clarified the concatenation strategy for imagery to account for image width variation. Described the possibility of duplicate list entries among consecutive slices.
		Table 3-6	Clarified the assembly strategy for items in the manifest file.
		Table 3-7	Clarified the concatenation strategy for quick-look imagery to account for image width variation.
		Table 3-8	Added the assembly strategy for the file format and changed the assembly strategy for the image width field from Include to Merge. Chaged the assembly strategy from Merge to Include for geo-key and geo-params tags.
		Table 3-9	Clarified the assembly of the line number in calibration and noise annotations.
		Table 3-10	Clarified the assembly of the byte offset in the swath timing annotations.
		Table 3-12	Clarified the concatenation strategy for the number of samples field to account for image width variation.
		Table 6-9	Corrected definition of dataObjectType
		Table 6-10	Corrected definition of byteStreamType
		Table 6-11	Added definition of referenceType
		Table 6-12	Added definition of checksumInformationType



ISSUE	DATE	PAGE(S)	DESCRIPTION
		Table 6-12	Corrected the order of the data in the Model Tie Point Tag.
		Figure 6-8 Table 6-16	Updated L2 OCN global attributes
		Figure 6-10 Table 6-18	Updated L2 OSW variables
		Figure 6-12 Table 6-20	Updated L2 RVL variables
		Table 6-58	Corrected the number of possible noise elements in the noise list to account for the assembled products.
		Table 6-63	Changed azimuth FM rate annotation to an array.
		Figure 6-18	Updated EAP figure
		Table 6-82	Changed EAP to complex and added roll field.
		Table 6-103	Changed type of line field from unsigned to signed.
3/0	February 12, 2015		Third issue
		Table 6-15	Added L2 OCN Dimension: length (cf. IPF-4)
		Table 6-16	Added L2 OSW component variables: oswEcmwfWindSpeed, oswEcmwfWindDirection (cf. IPF-4)
	June 16, 2015	Table 6-16	Changed description of the windSpeed and windDirection variables. (cf. IPF-4)
	June 18, 2015	Section 6.3.3	Changed noise and value formulas (cf. IPF-78, MPCS-845)
		Table 6-60	Changed formula for azimuthFmRate (cf. IPF-78, MPCS-833)
	July 21, 2015	Figure 6-9, Figure 6-10, Figure 6-11, Figure 6-12, Figure 6-13	Changed L2 OCN netcdf figures in order to take into account attributes, dimensions and variables.
	July 23, 2015	Table 6-91	Changed srgCoefficients and grsrCoefficients formulation to a generic formulation (cf. IPF-97)
		Table 6-25	Changed description of downlinkMissingLinesSignificantFlag variable (cf. IPF-93)
3/1	September 22, 2015	Table 6-16	Changed L2 OCN Attribute: iceSource (cf. IPF-99)

ISSUE	DATE	PAGE(S)	DESCRIPTION
			Added L2 OCN Attribute: stokesSource (cf. IPF-100)
			Added L2 OCN Attribute: windSource (cf. IPF-101)
			Changed description for L2 OCN Attribute AcquisitionStation
3/2	February 01, 2016	Table 6-16	[MPCS-1076] Added L2 OCN Attribute: owiNoiseCorrection
		Table 6-19	[MPCS-1076] Added two new variables related to owiNoiseCorrection, owiNesz (noise vector gridded on wind cell grid) and owiElevationAngle (elevation angle at the center of the wind cell grid pixels)
	March 14, 2016	Figure 6-9	[MPCS-1076] Added L2 OCN attribute owiNoiseCorrection to figure
		Figure 6-11	[MPCS-1076] Added the new owi variables (owiNoiseCorrection, owiNesz) to figure
		Table 6-45	[IPF-138] Clarified definition of Earth Fixed reference frame
		Table 6-7	[IPF-186] Correct spelling of organisation (with an s instead of a z)
3/3	September 26, 2016	Table 6-16	[MPCS-1174] Correction L2 format specifications in order to align the specification to the actual implementation for L2 OCN global attributes: <ul style="list-style-type: none"> <li>- Title: Correction of the spelling of the global attribute name</li> <li>- acquisitionStation attribute: the cardinality is reduced to 0 as this field is not provided</li> <li>- statevectorUTC: update of data type</li> <li>- statevectorPos / statevectorVel / stateVectorAcc: correction of the type (from float to double)</li> <li>- owiNoiseCorrection: clarification of the cardinality of this attribute with respect to different IPF versions</li> </ul>
		Table 6-17	[MPCS-1174] Correction L2 format specifications in order to align the specification to the actual implementation for L2 OCN dimensions: <ul style="list-style-type: none"> <li>- clarification of rvlSwath cardinality of SM and WV products</li> </ul>

ISSUE	DATE	PAGE(S)	DESCRIPTION
		Table 6-18	<p>[MPCS-1174] Correction L2 format specifications in order to align the specification to the actual implementation for L2 OSW components variables:</p> <ul style="list-style-type: none"> <li>- oswPartitions: Clarification of the number of partitions and their meaning and of their data types</li> <li>- oswPhi / oswLon / oswLat / oswDirmet / oswWindDirection / oswEcmwfWindDirection / oswIncidenceAngle, oswHeading: correction of the unit of direction provided as variable attribute</li> <li>- oswHs / oswWl / oswSnr / oswIconf: correction of the number of partitions used in order to compute the significant wave height</li> <li>- oswAmbiFac / oswIconf / oswInten, oswNv / oswKurt / oswWaveAge / oswLandFlag: correction of unit (adimensional)</li> </ul>
		Table 6-19	<p>[MPCS-1174] Correction L2 format specifications in order to align the specification to the actual implementation for L2 OWI components variables :</p> <ul style="list-style-type: none"> <li>- owiLon / owLat / owiIncidenceAngle / owiHeading / owiCalConstInci / owiWindDirection / owiEcmwfWindDirection / owiElevationAngle: clarification of the units</li> <li>- owiHs / owiWl / owDirmet / owiWindSeaHs: clarification of specific cases where a fillvalue is used</li> <li>- owiNesz: clarification of the cardinality of this attribute with respect to different IPF versions:</li> </ul>
		Table 6-20	<p>[MPCS-1174] Correction L2 format specifications in order to align the specification to the actual implementation for L2 RVL components variables:</p> <ul style="list-style-type: none"> <li>- for all variables: clarification of the dimensions for the various acquisition modes</li> </ul>
3/4	March 10, 2017	Sec. 6.3.3	Noise annotations updated in order to introduce denoising vectors along azimuth direction (cf. IPF-310)

ISSUE	DATE	PAGE(S)	DESCRIPTION
3/4	March 30, 2017	Table 6-17	Introduction of 3 new dimension oswKxBinSize, oswKyBinSize, oswLag to accommodate the Cartesian cross spectra output variable.  Add dimension owiPolarisation
		Table 6-18	Introduction of several new variables: oswCartSpec, oswKx, oswKy, oswQualityFlagPartition, oswQualityFlag, oswTotalHs  Introduction of variables of peak direction from group analysis: oswGroupDir, oswEllipsLength, oswEllipsLengthStdDev, oswEllipsWidth, oswEllipsWidthStdDev
		Table 6-19	Change of cardinality owiNrCs, owiNesZ in the case of dual polarization acquisition (adding the cross-polarisation information)  Remove of owiLandFlag replaced by owiMask allowing the annotation of landmask/iceMask/noDataAvailable.  Introduction of owiNrCsNesZCorr (noise corrected NRCS averaged on the wind grid).
		Table 6-15	Adding of IPF version in L2 OCN Netcdf global attribute
	28/08/2017	Table 6-17, Table 6-18, Table 6-19	Change ubyte to byte variables on L2 OCN Netcdf in order to maintain the NetCDF 3.4 format compliancy
	06/11/2017	Table 6-17	Precision on the variable oswKx and oswKy (frequency vectors of the cartesian cross spectra), which have been resp. normalized by variables oswGroundRgSize, oswAziSize
	06/11/2017	Table 6-17, Table 6-19	Review of the L2 variables units to be compliant with the udunit norm
	11/12/2017	Table 3-14	The datatake id in the Level 2 measurement file can be either in upper or lower case.
3/5	April 19, 2018	Table 3-9	Updated the assembly methods for noiseRangeVector and noiseAzimuthVector type.
		Table 6-102 Table 6-103	Updated the table title with the correct name of the types.
		Table 6-18	Change range to azimuth on oswCartSpecRe and oswCartSpecIm
3/6	January 7, 2019	Table 6-18	Update of OSW specification due to new low filter

ISSUE	DATE	PAGE(S)	DESCRIPTION
	June, 2019	Table 6-18	Add two new OSW variables <code>oswJx</code> <code>oswJy</code> relative to the Jacobian vector of the image cartesian cross spectra transformation <code>oswCartSpecRe</code> and <code>oswCartSpecIm</code> (non-linear resampling, only used to export the variable)
3/7	September 16, 2019	Table 6-18	Clarification content <code>oswQualityFlagPartition</code> . Addition of variables <code>oswPolSpecNV</code> and <code>oswHsNV</code> (IPF 3.30)
3/8	December 21, 2020	Figure 3-7  Table 6-18	Clarification of resolution class “_” when resolution class is not applicable  Clarification of <code>oswHs</code> , <code>oswHsNV</code> , <code>oswDirmet</code> , <code>oswIconf</code> variables: the number of partitions (five) corresponds to the <code>oswPartitions</code> dimensions  Clarification of <code>oswTotalHs</code> and <code>oswQualityFlag</code>  Introduction of <code>oswTotalHsStdev</code>  Correction of spelling (cathesian instead of cartesian)
3/9	April 28 2021	Table 6-4	Clarification of <code>textinfo</code> field in manifest file. Add some examples to illustrate it (IPF-440). Added <code>burstID</code> (IPF-469) and <code>RFI ADS</code> (IPF-470).  Changed <code>statevectorUtc</code> time format.  Added note on the calculation of the geolocation grid.
		Table 6-87 Table 6-16 Section 6.3.1.7 Table 3-19	Added <code>burstID</code> (IPF-469) and <code>RFI ADS</code> (IPF-470).  Changed <code>statevectorUtc</code> time format.  Added note on the calculation of the geolocation grid
3/10	November, 17 2021	Table 6-16 Table 6-18 Section 6.2.3	Change of L2 OCN products specification related to IPF 3.5.  Adding a new variable <code>oswNrcsNeszCorr</code>  Adding global attribute <code>oswNoiseCorrection</code>  Documentation or Clarification of pre-existing variables
3/11	February 18, 2022	Section 6.2.3.4	Clarification of L2 OCN product specification.  Add section 6.2.3.4 documenting the attributes allowed for each NetCDF variable

ISSUE	DATE	PAGE(S)	DESCRIPTION
3/12	September 19, 2022	Table 6-103  Figure 6-30  Section 3.3.5  Table 3-2 Table 3-3 Table 3-5 Table 3-7 Table 3-15 Table 3-16 Table 5-1 Table 6-122 New Section 6.2.4 New Figure 6-31  Table 6-16  Table 6-16 Table 6-18	<p>Clarification of the cardinality of the noiseAzimuthVectorList</p> <p>Uptdate of Figure 6-30 (preview) with a recent example</p> <p><b>Change relative to IPF 3.6 :</b></p> <p>Annotation of L0 A/C/N in manifest (three additionnal ressources)</p> <p>Introduction of Quicklook for SM and TOPS on L2 products of type s1level2rvlquicklook and s1level2owiquicklook and associated annotation owicolorbar and rvlcolorbar</p> <p>Global attribute about L2 substask (RVL/OSW/OWI) status</p> <p>Add new variables and global attributes to L2 OSW products to ease exploitation of the data</p>

## TABLE OF CONTENTS

<b>1</b>	<b>INTRODUCTION.....</b>	<b>1-1</b>
1.1	Purpose.....	1-1
1.2	Scope.....	1-1
1.3	Document Structure .....	1-1
<b>2</b>	<b>DOCUMENTS.....</b>	<b>2-1</b>
2.1	Applicable Documents.....	2-1
2.2	Reference Documents .....	2-2
<b>3</b>	<b>PRODUCT FORMAT OVERVIEW .....</b>	<b>3-1</b>
3.1	Products Overview.....	3-2
3.1.1	Level 1 Products Overview .....	3-4
3.1.2	Level 2 Products Overview .....	3-5
3.2	High Level Product Structure .....	3-6
3.3	Product Components.....	3-8
3.3.1	Manifest File .....	3-8
3.3.2	Measurement Data Sets .....	3-9
3.3.3	Annotation Data Sets.....	3-10
3.3.4	Representation Data Sets.....	3-11
3.3.5	Resources .....	3-12
3.4	Slice Products.....	3-13
3.4.1	Overview .....	3-13
3.4.2	Manifest File .....	3-21
3.4.3	Measurement Data Sets .....	3-23
3.4.4	Annotation Data Sets.....	3-27
3.5	Product Naming .....	3-33
3.5.1	Product .....	3-33
3.5.2	Manifest File .....	3-36
3.5.3	Data Sets.....	3-36
3.6	Product Conventions.....	3-39
3.6.1	Decisions .....	3-39
3.6.2	Content Table Conventions.....	3-40
3.6.3	Primitive Data Types.....	3-41
<b>4</b>	<b>LEVEL 1 PRODUCT SPECIFICATION .....</b>	<b>4-45</b>
4.1	Level 1 SLC Products .....	4-45
4.2	Level 1 GRD Products .....	4-47
<b>5</b>	<b>LEVEL 2 PRODUCT SPECIFICATION .....</b>	<b>5-1</b>
5.1	Level 2 OCN Products .....	5-1
<b>6</b>	<b>PRODUCT DATA SETS.....</b>	<b>6-1</b>
6.1	Manifest File .....	6-1
6.1.1	Information Package Map .....	6-4
6.1.2	Metadata Section .....	6-5
6.1.3	Data Object Section.....	6-13



# Sentinel-1

Ref: S1-RS-MDA-52-7441  
MPC Nom: DI-MPC-PB  
MPC Ref: MPC-0240  
Issue/Revision: 3/12  
Date: 19/09/2022

6.2	Measurement Data Sets.....	6-14
6.2.1	Level 1 Image.....	6-14
6.2.2	Level 1 Quick-look Image.....	6-17
6.2.3	Level 2 OCN Measurement Data .....	6-20
6.2.4	Level 2 Quick-look images .....	6-49
6.3	Annotation Data Sets .....	6-50
6.3.1	L1 Product Annotation Data Set .....	6-50
6.3.2	L1 Calibration Annotation Data Set.....	6-112
6.3.3	L1 Noise Annotation Data Set .....	6-116
6.3.4	L1 RFI Annotation Data Set.....	6-121
6.3.5	Map Overlay Annotation Data Set.....	6-130
6.3.6	Product Preview Annotation Data Set.....	6-132



## LIST OF FIGURES

Figure 1-1	Document Structure and Section Relationships .....	1-3
Figure 3-1	Sentinel-1 Product Family Tree .....	3-3
Figure 3-2	Sentinel-1 Product Composition Overview .....	3-7
Figure 3-3	Example of Include Assembly Strategy .....	3-15
Figure 3-4	Example of Merge Assembly Strategy .....	3-17
Figure 3-5	Example of Concatenate Assembly Strategy .....	3-20
Figure 3-6	Assembly of a L1 Image MDS .....	3-26
Figure 3-7	Sentinel-1 Product Naming Convention .....	3-34
Figure 6-1	Sentinel-1 Manifest File Structure .....	6-2
Figure 6-2	Information Package Map Structure .....	6-4
Figure 6-3	Metadata Section Structure and Content .....	6-6
Figure 6-4	Data Object Section Structure and Content .....	6-13
Figure 6-5	Grey-scale Single Polarisation Quick-look Images: Left VV Co-polarisation and Right VH Cross-polarisation .....	6-18
Figure 6-6	3 Channel (RGB) Composite Dual Polarisation VV/VH Quick-look Image .....	6-19
Figure 6-7	L2 OCN Product Top-level Format .....	6-20
Figure 6-8	L2 OCN Global Attributes .....	6-22
Figure 6-9	L2 OCN Dimensions .....	6-26
Figure 6-11	L2 OWI Component Variables .....	6-37
Figure 6-12	L2 RVL Component Variables .....	6-42
Figure 6-13	L2 Quick-look Images (Top quick-look-l2-rvl.png with associated rvl- colorbar.png ; bottom quick-look-l2-owi.png with associated owi- colorbar.png) .....	6-49
Figure 6-14	L1 Product Annotation Data Set .....	6-50
Figure 6-15	L1 Quality Information ADSR .....	6-53
Figure 6-16	L1 General ADSR .....	6-60
Figure 6-17	L1 Image ADSR .....	6-81
Figure 6-18	L1 Doppler Centroid ADSR .....	6-90
Figure 6-19	L1 Antenna Elevation Pattern ADSR .....	6-94
Figure 6-20	L1 Swath Timing ADSR .....	6-97
Figure 6-21	L1 Geo-location Grid ADSR .....	6-101
Figure 6-22	L1 Coordinate Conversion ADSR .....	6-104
Figure 6-23	L1 Swath Merging ADSR .....	6-107
Figure 6-24	Swath Merging .....	6-111
Figure 6-25	L1 Calibration Data Set .....	6-113
Figure 6-26	L1 Noise LUT Data Set .....	6-117
Figure 6-27	L1 RFI Data Set .....	6-122
Figure 6-28	Sentinel-1 Map Overlay Displayed in Google Earth .....	6-130
Figure 6-29	Map Overlay Annotation Data Set .....	6-131
Figure 6-30	Example Product Preview ADS .....	6-133

## LIST OF TABLES

Table 3-1	ADSR Summary for Sentinel-1 Manifest File .....	3-9
Table 3-2	Summary of Measurement Data Sets used by Sentinel-1 .....	3-9
Table 3-3	Summary of the Annotation Data Sets used by Sentinel-1 .....	3-10
Table 3-4	ADSR Summary for Level 1 Product Annotation ADS.....	3-11
Table 3-5	Data Set Representation Details .....	3-12
Table 3-6	Assembly of the Sentinel-1 Manifest File .....	3-21
Table 3-7	Assembly of the L1 Measurement Data Sets .....	3-23
Table 3-8	Assembly of L1 Image MDS TIFF/GeoTIFF Information .....	3-23
Table 3-9	Assembly of the L1 Annotation Data Sets .....	3-27
Table 3-10	Assembly of the Level 1 Product Annotation ADS .....	3-29
Table 3-11	Assembly of the L1 General Annotation ADSR .....	3-30
Table 3-12	Assembly of the L1 Image Annotation ADSR.....	3-31
Table 3-13	Sentinel-1 Product Naming Elements .....	3-35
Table 3-14	Sentinel-1 Data Set Naming Elements .....	3-37
Table 3-15	Measurement Data Set Naming Convention for Sentinel-1 .....	3-38
Table 3-16	Annotation Data Set Naming Convention for Sentinel-1.....	3-38
Table 3-17	Representation Data Set Naming Convention for Sentinel-1 .....	3-39
Table 3-18	Product Data Content Table Column Descriptions .....	3-40
Table 3-19	Primitive Data Types for Sentinel-1 Product Format.....	3-41
Table 3-20	Data Type - adsHeaderType.....	3-44
Table 4-1	Sentinel-1 Level 1 SLC Product Composition .....	4-46
Table 4-2	Level 1 Product Annotation DSR Applicable to Level 1 SLC Products.....	4-47
Table 4-3	Sentinel-1 Level 1 GRD Product Composition.....	4-48
Table 4-4	Level 1 Product Annotation DSR Applicable to Level 1 GRD Products.....	4-49
Table 5-1	Sentinel-1 Level 2 OCN Product Composition .....	5-1
Table 6-1	Element - XFDU.....	6-3
Table 6-2	Primitive Data Types for Sentinel-1 Manifest Format .....	6-3
Table 6-3	Data Type - informationPackageMapType .....	6-4
Table 6-4	Data Type - contentUnitType.....	6-5
Table 6-5	Data Type - metadataSectionType .....	6-6
Table 6-6	Data Type - metadataObjectType.....	6-6
Table 6-7	Mandatory Wrapped Metadata Elements for Sentinel-1 Products.....	6-8
Table 6-8	Data Type - dataObjectSectionType .....	6-13
Table 6-9	Data Type - dataObjectType .....	6-13
Table 6-10	Data Type - byteArrayType.....	6-13
Table 6-11	Data Type - referenceType.....	6-14
Table 6-12	Data Type - checksumInformationType.....	6-14
Table 6-13	Summary of TIFF Tags used in Sentinel-1 Products .....	6-15
Table 6-14	Summary of GeoTIFF Tags/Keys Used in Sentinel-1 Products .....	6-16

Table 6-15	L2 OCN Product.....	6-20
Table 6-16	L2 OCN Global Attributes .....	6-23
Table 6-17	L2 OCN Dimensions .....	6-26
Table 6-18	L2 OSW Component Variables.....	6-29
Table 6-19	L2 OWI Component Variables.....	6-38
Table 6-20	L2 RVL Component Variables.....	6-43
Table 6-21	L2 attributes for each variable .....	6-45
Table 6-22	Element - product .....	6-51
Table 6-23	Data Type - l1QualityInformationType.....	6-54
Table 6-24	Data Type - qualityDataListType .....	6-54
Table 6-25	Data Type - qualityDataType .....	6-54
Table 6-26	Data Type - downlinkQualityType.....	6-55
Table 6-27	Data Type - rawDataAnalysisQualityType .....	6-58
Table 6-28	Data Type - dopplerCentroidQualityType.....	6-58
Table 6-29	Data Type - imageQualityType .....	6-59
Table 6-30	Data Type - imageStatisticsType.....	6-59
Table 6-31	Data Type - l1GeneralAnnotationType .....	6-60
Table 6-32	Data Type - productInformationType .....	6-62
Table 6-33	Data Type - downlinkInformationListType .....	6-62
Table 6-34	Data Type - downlinkInformationType.....	6-63
Table 6-35	Data Type - bitErrorCountType .....	6-63
Table 6-36	Data Type - downlinkValuesType.....	6-65
Table 6-37	Data Type - dataFormatType.....	6-66
Table 6-38	Data Type - rangeDecimationType .....	6-66
Table 6-39	Data Type - swlListType .....	6-67
Table 6-40	Data Type - swlType .....	6-67
Table 6-41	Data Type - swstListType .....	6-67
Table 6-42	Data Type - swstType.....	6-67
Table 6-43	Data Type - pointingStatusListType .....	6-68
Table 6-44	Data Type - pointingStatusType.....	6-68
Table 6-45	Data Type - orbitListType .....	6-69
Table 6-46	Data Type - orbitType .....	6-69
Table 6-47	Data Type - positionType.....	6-70
Table 6-48	Data Type - velocityType.....	6-70
Table 6-49	Data Type - attitudeListType.....	6-70
Table 6-50	Data Type - attitudeType.....	6-71
Table 6-51	Data Type - rawDataAnalysisListType .....	6-72
Table 6-52	Data Type - rawDataAnalysisType .....	6-72
Table 6-53	Data Type - rawDataAnalysisSupportType.....	6-73
Table 6-54	Data Type - replicaInformationListType.....	6-73
Table 6-55	Data Type - replicaInformationType.....	6-74
Table 6-56	Data Type - referenceReplicaType .....	6-74
Table 6-57	Data Type - replicaListType.....	6-75

Table 6-58	Data Type - replicaType .....	6-76
Table 6-59	Data Type - noiseListType .....	6-78
Table 6-60	Data Type - noiseType .....	6-78
Table 6-61	Data Type - terrainHeightListType .....	6-79
Table 6-62	Data Type - terrainHeightType .....	6-79
Table 6-63	Data Type - azimuthFmRateListType .....	6-79
Table 6-64	Data Type - azimuthFmRateType .....	6-80
Table 6-65	Data Type - IIImageAnnotationType.....	6-82
Table 6-66	Data Type - imageInformationType .....	6-82
Table 6-67	Data Type - sliceListType.....	6-83
Table 6-68	Data Type - sliceType .....	6-84
Table 6-69	Data Type - imageStatisticsType.....	6-84
Table 6-70	Data Type - processingInformationType.....	6-84
Table 6-71	Data Type - swathProcParamsListType .....	6-86
Table 6-72	Data Type - swathProcParamsType .....	6-87
Table 6-73	Data Type - processingParametersType.....	6-87
Table 6-74	Data Type - inputDimensionsListType .....	6-88
Table 6-75	Data Type - inputDimensionsType .....	6-88
Table 6-76	Data Type - IIDopplerCentroidType.....	6-91
Table 6-77	Data Type - dceBlockListType .....	6-91
Table 6-78	Data Type - dcEstimateType .....	6-91
Table 6-79	Data Type - fineDceListType.....	6-92
Table 6-80	Data Type - fineDceType .....	6-93
Table 6-81	Data Type - IIAntennaPatternType.....	6-94
Table 6-82	Data Type - antennaPatternListType.....	6-94
Table 6-83	Data Type - antennaPatternType .....	6-95
Table 6-84	Data Type - IISwathType.....	6-98
Table 6-85	Data Type - burstListType.....	6-98
Table 6-86	Data Type - burstIdType .....	6-98
Table 6-87	Data Type - burstType.....	6-99
Table 6-88	Data Type - IIGeolocationGridType.....	6-102
Table 6-89	Data Type - geolocationGridPointListType .....	6-102
Table 6-90	Data Type - geolocationGridPointType .....	6-102
Table 6-91	Data Type - IICoordinateConversionType .....	6-104
Table 6-92	Data Type - coordinateConversionListType .....	6-105
Table 6-93	Data Type - coordinateConversionType .....	6-105
Table 6-94	Data Type - IISwathMergeType .....	6-108
Table 6-95	Data Type - swathMergeListType.....	6-108
Table 6-96	Data Type - swathMergeType .....	6-108
Table 6-97	Data Type - swathBoundsListType .....	6-109
Table 6-98	Data Type - swathBoundsType .....	6-109
Table 6-99	Element - calibration .....	6-114
Table 6-100	Data Type - calibrationInformationType.....	6-114

Table 6-101	Data Type - calibrationVectorListType.....	6-114
Table 6-102	Data Type - calibrationVectorType.....	6-115
Table 6-103	Element - noise.....	6-118
Table 6-104	Data Type - noiseRangeVectorListType.....	6-118
Table 6-105	Data Type - noiseRangeVectorType.....	6-118
Table 6-106	Data Type - noiseAzimuthVectorListType.....	6-119
Table 6-107	Data Type - noiseAzimuthVectorType.....	6-119
Table 6-108	Element - rfi.....	6-123
Table 6-109	Element - rfiDetectionFromNoiseReportList.....	6-124
Table 6-110	Element - rfiDetectionFromNoiseReport.....	6-124
Table 6-111	Element - rfiBurstReportList.....	6-125
Table 6-112	Element - rfiBurstReportType.....	6-125
Table 6-113	Element - timeDomainRfiReport.....	6-126
Table 6-114	Element - frequencyDomainRfiBurstReport.....	6-126
Table 6-115	Element - isolatedRfiReport.....	6-127
Table 6-116	Element - timeDomainRfiBlockReportList.....	6-127
Table 6-117	Element - timeDomainRfiBlockReport.....	6-127
Table 6-118	Element - frequencyDomainRfiBlockReportList.....	6-128
Table 6-119	Element - frequencyDomainRfiBlockReport.....	6-128
Table 6-120	Element - frequencyDomainPersistentRfiFrequencyMask.....	6-129
Table 6-121	Root element - kml.....	6-131
Table 6-122	Data Type – kml:DocumentType.....	6-131
Table 6-123	Data Type – kml:FolderType.....	6-131
Table 6-124	Data Type - kml:GroundOverlayType.....	6-132
Table 6-125	Data Type - kml:LinkType.....	6-132
Table 6-126	Data Type - gx:LatLonQuadType.....	6-132
Table 6-127	Contents of the Product Preview ADS.....	6-135

## ACRONYMS AND ABBREVIATIONS

ADS	Annotation Data Set
ADSR	Annotation Data Set Record
AEP	Antenna Elevation Pattern
AN	Azimuth Notch
ANX	Ascending Node Crossing
ASAR	Advanced SAR
ASCII	American Standard Code for Information Interchange
BAQ	Block Adaptive Quantisation
BigTIFF	Big Tag Image File Format
CCN	Contract Change Notice
CCSDS	Consultative Committee for Space Data Systems
CDR	Critical Design Review
CDRL	Contract Data Requirements List
COTS	Commercial off the Shelf
CRC	Cyclic Redundancy Check
dB	DeciBel
DC	Doppler Centroid
DCE	Doppler Centroid Estimation/Estimate
DN	Digital Number
DS	Data Set
DSR	Data Set Record
ECC	Event Control Code
ECMWF	European Centre for Medium-Range Weather Forecasts
EN	Elevation Notch
ESA	European Space Agency
ESRIN	European Space Research Institute
EW	Extra Wide Swath
FDBAQ	Flexible Dynamic Block Adaptive Quantisation
FM	Frequency Modulation
FR	Full Resolution
GB	Giga Byte
GEBCO	General Bathymetric Chart of Oceans

GeoTIFF	Geo-reference Tag Image File Format
GMES	Global Monitoring for Environment and Security
GMF	Geophysical Model Function
GRD	Ground Range, Multi-look, Detected
HH	Horizontal polarisation (Tx & Rx)
HR	High Resolution
HTML	HyperText Markup Language
HV	Horizontal Vertical polarisation
Hz	Hertz
I/Q	In-phase/Quadrature
ICD	Interface Control Document
ID	Identifier
IPF	Instrument Processing Facility
ISLR	Integrated Side Lobe Ratio
ISP	Instrument Source Packet
IW	Interferometric Wide Swath
Km	Kilometre
KML	Keyhole Markup Language
L0	Level Zero
L1	Level One
L2	Level Two
LUT	Look-up Table
m	metre
MDS	Measurement Data Set
MHz	Megahertz
MR	Medium Resolution
N/A	Not Applicable
NetCDF	Network Common Data Form
NRCS	Normalised Radar Cross Section
OCN	L2 Ocean Product
OSW	Ocean Swell Spectra
OWI	Ocean Wind Field
PDR	Preliminary Design Review
PG	Product Generation

PNG	Portable Network Graphics
pol.	Polarisation
PRF	Pulse Repetition Frequency
PRI	Pulse Repetition Interval
RDA	Raw Data Analysis
RDS	Representation Data Set
RGB	Red Green Blue
RID	Review Item Disposition
RMS	root mean squared
RVL	Radial Surface Velocity
S-1	Sentinel-1
SAR	Synthetic Aperture Radar
SAS	SAR Antenna Sub-system
SES	SAR Electronic Sub-system
SI	International System of Units
SLC	Single Look Complex
SM	Stripmap
SOW	Statement of Work
SPPDU	Space Packet Protocol Data Unit
SWL	Sampling Window Length
SWST	Sampling Window Start Time
TBC	To Be Confirmed
TBD	To Be Determined
TIFF	Tag Image File Format
TOPSAR	Terrain Observation with Progressive Scanning SAR
Tx	Transmit
URL	Uniform Resource Locator
UTC	Universal Time Coordinated
VH	Vertical Horizontal polarisation
VV	Vertical polarisation
W3C	World Wide Web Consortium
WGS 84	World Geodetic System (1984)
WV	Wave
XFDU	XML Formatted Data Unit





# Sentinel-1

Ref: S1-RS-MDA-52-7441  
MPC Nom: DI-MPC-PB  
MPC Ref: MPC-0240  
Issue/Revision: 3/12  
Date: 19/09/2022

XML eXtensible Markup Language  
ZDT Zero Doppler Time

## 1 INTRODUCTION

This section introduces the purpose, scope and structure of the document.

### 1.1 Purpose

This document defines the detailed product format for all Sentinel-1 Level 1 (L1) and Level 2 (L2) products. It specifies the content and format of the products generated by the Sentinel-1 Instrument Processing Facility (IPF).

### 1.2 Scope

This product specification satisfies the Sentinel-1 detailed L1 product format (deliverable PFL1-4) and the Sentinel-1 detailed L2 product format (deliverable PFL2-3) from the ESA Statement of Work (SOW) [A-1] with the modifications described in the Sentinel-1 IPF Contract Change Notice N. 2, Changes in ESRIN Contract No. 21722/08/I-LG [A-4].

This document specifies the content and format of Sentinel-1 L1 and L2 products for the four Sentinel-1 Synthetic Aperture Radar (SAR) acquisition modes: Stripmap (SM); Interferometric Wide Swath (IW); Extra Wide Swath (EW); and Wave (WV). The performance and characteristics for each of the products in the Sentinel-1 product family are detailed in the Sentinel-1 Product Definition [A-3]. The definition of Level 0 (L0) products is contained in the Sentinel-1 L0 Product Format Specification [R-8] and is not part of this document.

The Sentinel-1 product schema files form the definitive source for the content and format of Sentinel-1 products. The schema files are included in Appendix A and are distributed with every Sentinel-1 L1 and L2 product.

### 1.3 Document Structure

This document is structured as follows:

- **Section 1** introduces the purpose, scope and structure of the document;
- **Section 2** lists the applicable and reference documents;
- **Section 3** introduces the objectives and key concepts of the specification and presents an overview of the product format;
- **Section 4** defines the collections of data sets (DS) from Section 6 that make up each Sentinel-1 L1 product;

- **Section 5** defines the collections of data sets from Section 6 that make up each Sentinel-1 L2 product;
- **Section 6** describes the contents and format of each Sentinel-1 L1 and L2 data set. This section presents an abstract view of the details of each data set contained in the schemas defined in Appendix A and is intended for users of all levels;
- **Appendix A** contains the eXtensible Markup Language (XML) schema files that define the content and format of all Sentinel-1 L1 data sets. The XML schema files are the definitive source for the Sentinel-1 L1 product format. This section is intended for an audience with an understanding of XML Schema.

Within this document, Sections 1 and 2 are independent and stand-alone in the respect that they do not rely on other sections within the document for context; however, Sections 3 through 6 and Appendix A deserve special attention because inter-dependencies do exist between these sections of the document. Figure 1-1 presents a graphical view of the structure of the sections described in the list above and the relationships between each.

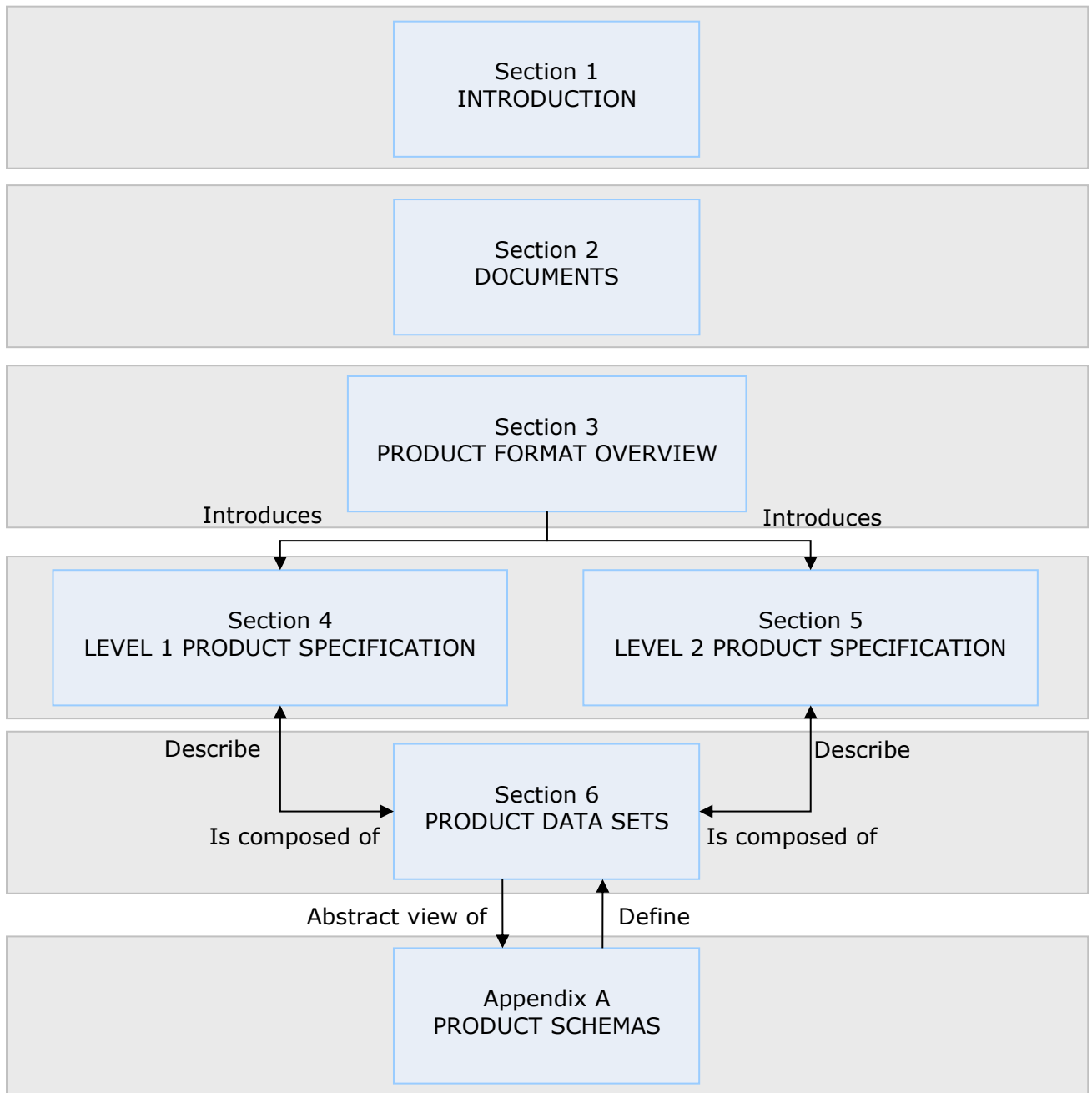

**Figure 1-1 Document Structure and Section Relationships**

## 2 DOCUMENTS

### 2.1 Applicable Documents

The following documents of the date/revision indicated form part of this document to the extent referenced herein.

- A-1 GMES-DFPR-EOPG-SW-07-00006 Sentinel-1 Product Definitions & Instrument Processing Facility Development Statement of Work, Issue/Revision 4/1, 23-05-2008. ESA.
- A-2 S1-RS-MDA-52-7452 Sentinel-1 IPF System Requirements Specification. Issue/Revision 2/3. Feb. 18, 2013. MDA.
- A-3 S1-RS-MDA-52-7440 Sentinel-1 Product Definition, Issue/Revision 2/4, Aug. 23, 2012. MDA.
- A-4 CCN No. 2 Contract Change Notice N. 2, Changes in ESRIN Contract No. 21722/08/I-LG, June 21, 2010. MDA
- A-5 01-7416A MDA Proposal to ESA for Sentinel-1 IPF Contract Change Request #04, Nov. 13, 2012.
- A-6 GMES-GSEG-EOPG-SW-12-0037 Sentinel-1 IPF Development Change Request No. 4, Issue/Revision ½, Oct. 25, 2012. ESA.

## 2.2 Reference Documents

The following documents provide useful reference information associated with this document. These documents are to be used for information only and changes to the date/revision number (if provided) shall not make this document out of date.

R-1		XML Formatted Data Unit Structure and Construction Rules. September 15, 2004. CCSDS.
R-2		XML 1.1 Second Edition, W3C Recommendation, 16 August 2006, Bray et al.
R-3		XML Schema Part 1: Structures Second Edition, W3C Recommendation, 28 October 2004, Thompson et al.
R-4		XML Schema Part 2: Datatypes Second Edition, W3C Recommendation, 28 October 2004, Biron et al.
R-5		TIFF Revision 6.0, June 3, 1992. Adobe Systems Incorporated.
R-6		GeoTIFF Format Specification, GeoTIFF Revision 1.0, Version 1.8.2, 28 December 2000, Ritter and Ruth.
R-7		BigTIFF File Format Proposal, Aware Systems.
R-8	S1PD.SP.00110.ASTR	Sentinel-1 L0 Product Format Specifications, Issue/Revision 1/7, Dec 20, 2012. ACS.
R-9	GMES-S1GS-EOPG-TN-10-0001	Sentinel-1 Products Naming Standard Convention, Issue 1/1, July 01, 2010, ESA.
R-10	OGC 07-147r2	KML, Version 2.2, April 14, 2008, Open Geospatial Consortium Inc.
R-11		Portable Network Graphics Specification Second Edition, W3C Recommendation, 10 November 2003.



# Sentinel-1

Ref: S1-RS-MDA-52-7441  
MPC Nom: DI-MPC-PB  
MPC Ref: MPC-0240  
Issue/Revision: 3/12  
Date: 19/09/2022

- R-12 Network Common Data Form  
(NetCDF) Users Guide, NetCDF  
Version 4.0.1, March 2009, Unidata.
- R-13 Google extensions to KML 2.2:  
<http://code.google.com/apis/kml/schema/kml22gx.xsd>. 2009 Google Inc.
- R-14 S1-TN-MDA-52-7445 Sentinel-1 Level 1 Detailed  
Algorithm Definition, Issue 2/3, Mar.  
23, 2021, MPC.

## 3 PRODUCT FORMAT OVERVIEW

The objectives of this specification are to define a Sentinel-1 product format for the L1 and L2 products defined in the Sentinel-1 Product Definition [A-3] that:

- applies to Sentinel-1 L1 and L2 products;
- contains the complete set of parameters and annotations required for calibration, analysis, quality assessment and post-processing of the product;
- supports the harmonisation of product formats across a multitude of Global Monitoring for Environment and Security (GMES) missions;
- supports a computer-based approach for validation of the consistency and content of the product; and,
- uses technologies that are current and widely supported to ensure ease of use for end users.

In order to meet these objectives, the Sentinel-1 product format leverages the following key concepts:

- the product format is based on SAFE, an XML-based format that has the following advantages:
  - XML is an ASCII based language that is both human and machine readable;
  - XML is widely supported by Commercial off the Shelf (COTS) tools including image processors, databases, browsers and translators;
  - XML supports a computer-based approach to format and content validation through the use of XML schema files;
  - SAFE uses a data wrapping technique that provides the flexibility to support any binary data format (making the format scalable enough to represent all levels of Sentinel-1 products);
  - SAFE is endorsed as the recommended product format for the harmonisation of products across GMES missions by the GMES Product Harmonisation Study;
- the product annotations are based on ENVISAT ASAR heritage, have been augmented to include the specialisations required to fully support Sentinel-1 and have been enhanced by the experience from other SAR missions like RADARSAT-2 and TerraSAR-X; and
- the data formats selected to represent images and measurement data (GeoTIFF, PNG, NetCDF) within the products are based on industry standard formats.



## 3.1 Products Overview

The Sentinel-1 IPF supports the generation of L1 and L2 products for the following four SAR acquisition modes:

- Stripmap (SM) – A standard SAR stripmap imaging mode where the ground swath is illuminated with a continuous sequence of pulses while the antenna beam is pointing to a fixed azimuth and elevation angle. Refer to Section 3.3.1 of [A-3] for a detailed description of SM.
- Interferometric Wide Swath (IW) – Data is acquired in 3 swaths using the Terrain Observation with Progressive Scanning SAR (TOPSAR) imaging technique. In IW mode bursts are synchronised from pass to pass to ensure the alignment of interferometric pairs. Refer to Section 3.3.2 of [A-3] for a detailed description of IW.
- Extra Wide Swath (EW) – Data is acquired in 5 swaths using the TOPSAR imaging technique. EW mode provides very large swath coverage at the expense of spatial resolution. Refer to Section 3.3.3 of [A-3] for a detailed description of EW.
- Wave (WV) – Data is acquired in small stripmap scenes called “vignettes”, situated at regular intervals of 100 km along track. The vignettes are acquired in ‘leap frog’ mode; i.e., one vignette is acquired at a near range incidence angle while the next vignette is acquired at a far range incidence angle. Refer to Section 3.3.4 of [A-3] for a detailed description of WV.
- Elevation Notch (EN) and Azimuth Notch (AN) – The notch acquisition modes are instrument calibration modes used for the determination of elevation pointing. They are fully based on SM acquisition parameters with the main difference being the excitation coefficients used during the acquisition of measurement data.

The Sentinel-1 IPF is capable of generating a family of Level 1 and Level 2 products from the four SAR measurement modes and the tree illustrating the Sentinel-1 family of products is presented in Figure 3-1.

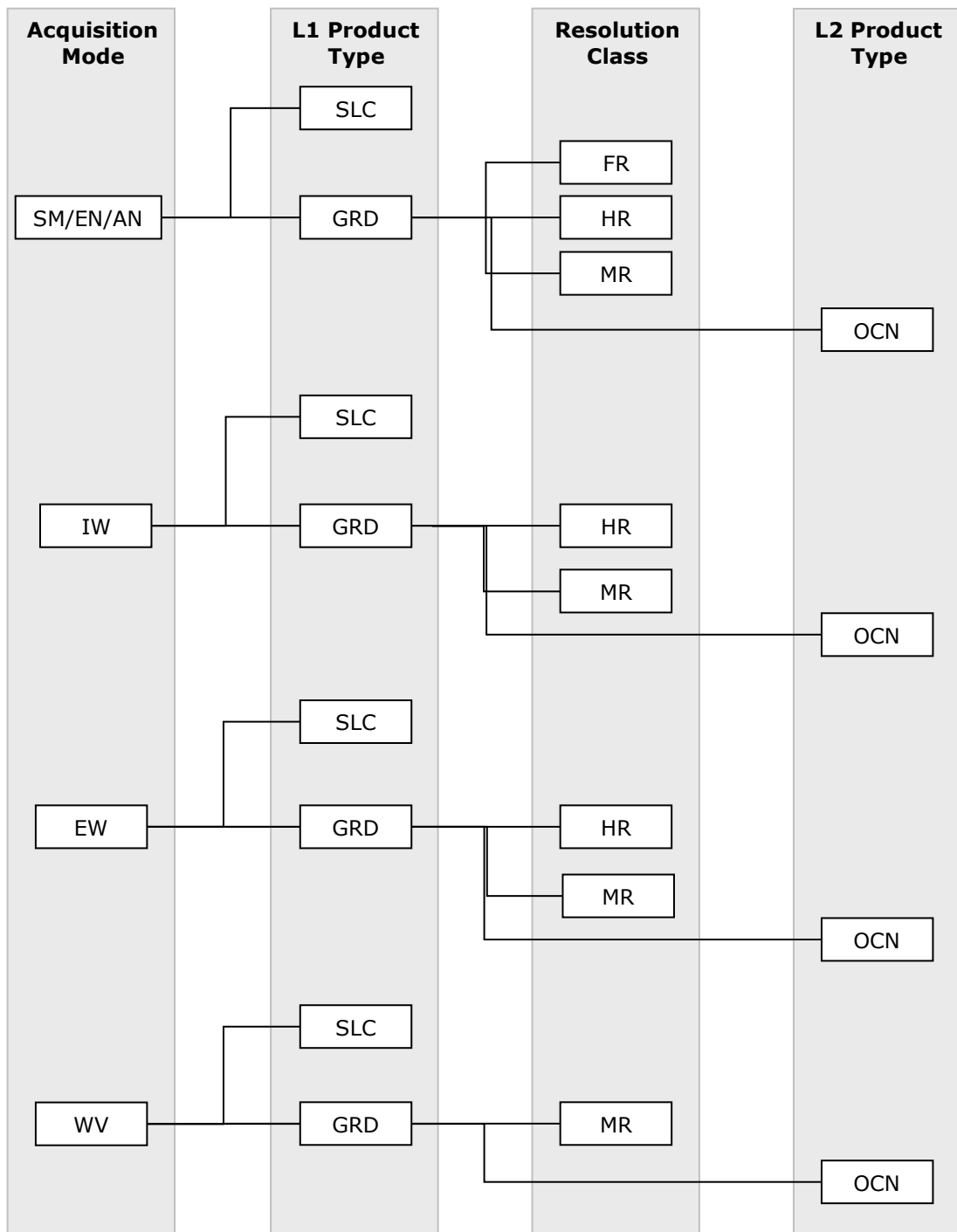

**Figure 3-1 Sentinel-1 Product Family Tree**

## 3.1.1 Level 1 Products Overview

The following types of L1 products are generated by the Sentinel-1 IPF:

- Slant Range, Single-Look Complex (SLC); and
- Ground Range, Multi-Look, Detected (GRD).

SLC products are images in the slant range by azimuth imaging plane, in the image plane of satellite data acquisition. Each image pixel is represented by a complex (I and Q) magnitude value and therefore contains both amplitude and phase information. The processing for all SLC products results in a single look in each dimension using the full available signal bandwidth. The imagery is geo-referenced using orbit and attitude data from the satellite.

GRD products lie in the ground range by azimuth surface, with image coordinates oriented along ground range and flight direction. To convert from imaging slant range coordinates to ground range coordinates, a slant to ground projection is performed onto an ellipsoid (typically the WGS84 ellipsoid) corrected using terrain height, which varies in azimuth and is constant in range. The standard GRD products are detected, multi-look products, with approximately square resolution cells and square pixel spacing. Multi-look is a processing property that results in images with reduced speckle, but also with reduced resolution: the more looks the less speckle noise and the lower the resolution.

The resolution of SLC products is determined by the acquisition mode; however, the GRD products can be further classified into a resolution class characterised by the acquisition mode employed as well as by the level of multi-look performed during processing:

- Full Resolution (FR) products;
- High Resolution (HR) products; and
- Medium Resolution (MR) products.

For detailed descriptions of the properties and characteristics of each product type for the various modes, refer to [A-3].

### 3.1.1.1 Annotation Products

The IPF is also capable of generating Annotation products for the L1 SLC and GRD product types. Annotation products are generated for internal PDGS purposes and are not distributed externally to users.

L1 Annotation products are generated using the same processing as the “nominal” products and so are identical to the nominal products except that they contain only the product annotations and exclude the image MDS; this results in a product containing all the metadata but with a significantly reduced data volume. For SM, IW and EW modes annotation products may contain a Quick-look image for a visual reference of

the product scene coverage. For detailed descriptions of the properties and characteristics of each product type for the various modes, refer to [A-3].

For L2 products, the metadata in the annotation product is based on the internal L1 SLC product that was used as input to the L2 Processor.

## 3.1.2 Level 2 Products Overview

The Sentinel-1 IPF is capable of generating an L2 Ocean (OCN) product from input L1 products (note that these input SLC and GRD products are produced using different parameters than standard L1 products, specifically for the purpose of L2 processing). The L2 OCN product is composed of three components: an Ocean Swell Spectra (OSW) component; an Ocean Wind Field (OWI) component; and, a Radial Velocity (RVL) component. Each of the three components is described in the subsequent sections (respectively).

### 3.1.2.1 Level 2 Ocean Swell Spectra Component

The OSW component of the OCN product is a two-dimensional ocean surface swell spectrum estimated from a Level 1 SLC image. The OSW component also contains one estimate of the wind speed and direction per ocean swell spectrum, as well as parameters derived from the ocean swell spectra (integrated wave parameters) and from the vignette (image statistics).

The OSW component is generated from SM and WV data. It cannot be generated from TOPSAR data, since individual looks with sufficient time separation are required. The obtained inter look time separation within one burst is too short due to the progressive scanning (i.e. short dwell time). For WV data, there is one OSW spectra derived per vignette. For SM data, multiple spectra are derived from the image on a ground-range grid.

Refer to Section 6.2.1.1 of [A-3] for the detailed description and definition of the L2 OSW component.

### 3.1.2.2 Level 2 Ocean Wind Field Component

The OWI component of the OCN product is a ground-range gridded estimate of the surface wind speed and direction at a height of 10 m above the ocean surface, derived from an input L1 GRD image from SM, IW or EW mode. Refer to Section 6.2.1.2 of [A-3] for the detailed description and definition of the L2 OWI component.

### 3.1.2.3 Level 2 Radial Surface Velocity Component

The RVL component of the OCN product is calculated based on the difference between the measured L2 Doppler grid and the geometrical Doppler calculated by the L1 processor. The measured L2 Doppler grid accounts for the antenna mispointing

Doppler by including the antenna error matrix in the antenna model synthesis. The RVL estimates are produced on a ground-range grid, although the input product is SLC.

Refer to Section 6.2.1.3 of [A-3] for the detailed description and definition of the L2 RVL component.

## 3.2 High Level Product Structure

This section describes the high-level format and structure that is applicable to all Sentinel-1 L1 and L2 products. The term “product” simply refers to a directory folder that contains a collection of information. Sentinel-1 products contain related information grouped together into files referred to as data sets, and data sets are collected and grouped together to form a complete product.

The Sentinel-1 product format is a specialisation of the SAFE format and thus inherits its information, logical, and physical models from the SAFE standard. One of the key advantages of the SAFE format is its ability to capture how the information in a product is logically interconnected and validated; however, the focus of this product specification document is to present the physical structure and composition of Sentinel-1 products.

The detailed implementation of the SAFE format for Sentinel-1 products is managed in the XML schema files contained in Appendix A. The purpose of this document is to clearly and concisely convey the Sentinel-1 product format in a manner that allows the user to gain understanding without knowledge of the details at the XML schema level; that is:

- this document deals with what information is contained in a product and where it is located; and
- the schema files in Appendix A define the detailed product format as a SAFE specialisation.

Figure 3-2 presents a conceptual overview of the composition of Sentinel-1 products.

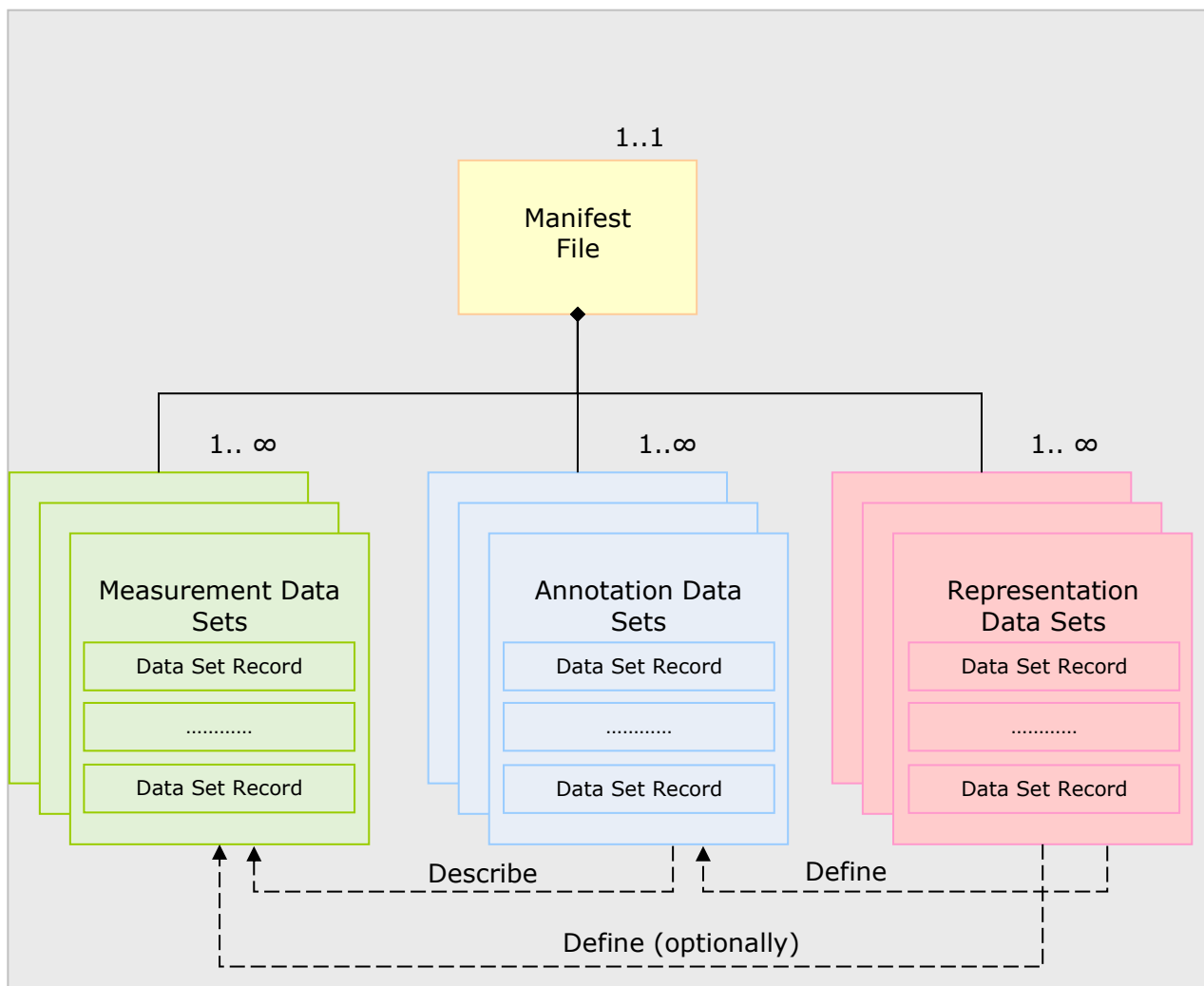

**Figure 3-2 Sentinel-1 Product Composition Overview**

Every Sentinel-1 product contains a manifest file, which can be thought of as the top level of each product as it describes the content and the structure of the product.

The product data and metadata are contained in data set records (DSR). Data set records are composed of nested structures that contain fields of information logically related and grouped together within the DSR. Data set records are logically grouped together to form files called data sets (DS). The structure and content of one type of DSR is always the same; however, a dataset may contain multiple different types of DSRs. For example, the L1 Product Annotation Data Set (ADS) describes the properties of the product. The information fields in this data set are grouped into the DSRs to which they apply; for example, the fields describing the general properties of the product are found in the generalAnnotation DSR while the Doppler information is found in the dopplerCentroid DSR. The generalAnnotation and dopplerCentroid DSRs differ in structure and content because of the information that each contains; however, all generalAnnotation DSRs are identical to each other in structure and content and all dopplerCentroid DSRs are identical to each other in structure and content. These rules apply to all DSRs within Sentinel-1 products. This concept

differs from the ENVISAT product format in which the structure of all DSRs within a data set is the same.

There are three categories of data sets for Sentinel-1 products:

- **Measurement data sets (MDS)** contain images derived from instrument data (L1) or binary information products derived from the instrument data or images (L1 and L2). A more detailed description of the measurement data sets follows in Section 3.3.2 and the definitions are specified in Section 6.2;
- **Annotation data sets (ADS)** contain metadata that describes the properties and characteristics of the measurement data or how the measurement data was generated. A more detailed description of the annotation data sets follows in Section 3.3.3 and the definitions are specified in Section 6.2.3.4; and
- **Representation data sets (RDS)** contain information about the format or syntax of the measurement and annotation data sets and can be used to validate and exploit these data. A more detailed description of the representation data sets follows in Section 3.3.4.

In addition to physical data sets, Sentinel-1 products also contain information called resources. Resources are any data that have a direct influence over how the product was created, such as input files and auxiliary or external data files. Resources are not physically included in the product but are identified by special fields in the manifest file. Resources are described in more detail in Section 3.3.5.

## 3.3 Product Components

This section introduces the components and data sets that may be included in a Sentinel-1 product.

### 3.3.1 Manifest File

The manifest file is an XML file that forms the core of every Sentinel-1 product. The manifest file serves two important purposes within the product:

1. It contains information about the collection of data sets that comprise the product, the nature of each data set and how the data sets relate to one another; and
2. It contains general information about the product that is useful for cataloguing and identification purposes.

The manifest file can be thought of as the map of each product and there is one manifest file present in every product.

Table 3-1 introduces the Annotation Data Set Records (ADSR) contained in the manifest file for Sentinel-1 products and a more detailed description of the structure of, and the information contained in the manifest file is presented in Section 6.1.

**Table 3-1 ADSR Summary for Sentinel-1 Manifest File**

Data Set Record	Description	Reference
Information Package Map	The information package map contains a high-level textual description of the product and references to all of the MDS and ADS contained within the product.	6.1.1
Metadata Section	The metadata section contains a minimal set of wrapped product metadata that can be used for product identification and cataloguing, and it also contains references to each of the ADS contained within the product.	6.1.2
Data Object Section	The data object section contains references to the physical location of each MDS and ADS file comprising the product with a description of the file format, file location and checksum of each file.	6.1.3

### 3.3.2 Measurement Data Sets

Measurement data sets are binary encoded files that contain:

1. images derived from instrument data (L1); or
2. binary information products derived from the instrument data or images (L1 and L2).

The content and format of the measurement data sets is described in detail in Section 6.2; however, in order to provide context for the following sections, Table 3-2 introduces the measurement data sets and provides a general description of the content and format of each.

**Table 3-2 Summary of Measurement Data Sets used by Sentinel-1**

Data Set Name	Description	Format	Reference
L1 Image	Image data sets contain SAR data that has been processed into an image.	GeoTIFF	6.2.1
Quick look Image	Quick look image data sets are an averaged, decimated version of the image data set that results in a smaller image file that is suitable for previewing products.	PNG	6.2.2
L2 Ocean	The L2 Ocean data set contains an Ocean Swell Wave Spectra (OSW), an Ocean Wind Field (OWI) and a Radial Surface Velocity vector (RVL) estimated from input L1 SAR images (note that these input L1 SLC and GRD products are produced using different parameters than standard L1 products, specifically for the purpose of L2 processing).	NetCDF	6.2.3



Data Set Name	Description	Format	Reference
L2 Quicklook images	Starting with IPF 3.6.0 a, two types of L2 Quicklooks are included in the products for SM and TOPS: respectively related to OWI (wind field measurement), and RVL (radial Velocity measurement)	PNG	6.2.4

### 3.3.3 Annotation Data Sets

Annotation data sets are files that contain metadata – data that describes other data – that describe characteristics of the product.

The general structure and content of the annotation data is described in detail in Section 6; however, Table 3-3 introduces the different types of annotation data sets and provides a general description of the information contained in each. Table 3-4 introduces all of the Annotation DSRs (ADSR) that may be included in the Level 1 Product Annotation DS and within Section 4 the exact ADSR included with each specific product is detailed.

**Table 3-3 Summary of the Annotation Data Sets used by Sentinel-1**

Data Set Name	Description	References
Level 1 Product Annotation	The Level 1 product annotation data set contains the metadata that describes the main characteristics of the product such as: state of the platform during acquisition, image properties, Doppler information, geographic location, etc. A summary of annotation data set records included in the product annotation data set is presented in Table 3-4.	6.3.1 A2
Level 1 Calibration	The calibration data set contains calibration information and the beta nought, sigma nought, gamma and digital number (DN) Look-up Tables (LUT) that can be used for absolute product calibration.	6.3.2 A3
Level 1 Noise	The noise data set contains the estimated thermal noise LUT.	6.3.3 A4
Level 1 RFI	The RFI data set contains the radio frequency interference (RFI) reports	6.3.4 A5
Map Overlay	The map overlay data set includes information about the geographic coverage of the product.	6.3.5
Product Preview	The product preview data set presents a graphical overview of the product using the Quick-look image MDS (and L2 Quick-looks) and provides access to the data sets contained within the product through hyperlinks.	6.3.6
ColorBar	Starting with IPF 3.6.0 and associated to L2 Quicklooks relative to OWI and RVL, ColorBar figures annotate the colors used for the quicklook representation	6.2.4

**Table 3-4 ADSR Summary for Level 1 Product Annotation ADS**

Data Set Record	Description	Reference
Quality Information	The quality information data set represents a summary of quality flags and values for information extracted from other data set records.	6.3.1.1
General Annotation	The general annotation data set record contains a summary of information extracted from the downlink echo, calibration and noise packets used to generate all Level 1 products.	6.3.1.2
Image Annotation	The image annotation data set record contains properties and parameters for all Level 1 slant range and ground range images.	0
Doppler Centroid	The Doppler centroid (DC) data set record contains the Doppler centroid estimate (DCE) list, which contains the Doppler estimates calculated from orbit geometry and data analysis. These estimates are used by the IPF during image processing and focusing.	6.3.1.4
Antenna Pattern	The antenna pattern data set record contains a list of vectors of the antenna elevation pattern values that have been updated along track and used to correct the radiometry during image processing.	6.3.1.5
Swath Timing	The swath timing data set record contains information for each burst within a swath for TOPSAR products and is specific to IW and EW SLC products. The purpose of the information included in this file is to allow users of IW and EW products to extract bursts from the image files included with the product.	6.3.1.6
Geolocation Grid	The geolocation grid data set record contains a matrix of points defining the slant range time, incidence angle, and geodetic latitude and longitude positions at various range and azimuth positions within the image.	6.3.1.7
Coordinate Conversion	The coordinate conversion data set record contains information required to perform the conversions between the slant-range and ground-range coordinate systems. This DSR is present only if slant range to ground range conversion was performed during processing.	6.3.1.8
Swath Merging	The swath merging data set record contains information about how multiple swaths were stitched together to form one large contiguous swath. This data set record only applies to IW and EW GRD products.	6.3.1.9

### 3.3.4 Representation Data Sets

The representation data sets define the detailed format and content of the datasets within the Sentinel-1 products using XML Schema [R-3] and [R-4] and implement the Sentinel-1 specialisations of the SAFE specification. Each representation data set is an XML formatted schema file with ASCII encoding and an “.xsd” file extension.

Representation data sets are included with every Sentinel-1 product and may be used by image processors to interpret and manipulate measurement and annotation data sets and can be used by XML validation tools to validate the format and content of the annotation data sets. Table 3-5 below describes the Sentinel-1 L1 and L2 datasets and indicates whether or not each has an associated RDS.

**Table 3-5 Data Set Representation Details**

Data Set Name	Data Set Type	RDS	Definition
Level 1 Product Annotation	Annotation Data Set	Yes	A2
Level 1 Calibration	Annotation Data Set	Yes	A3
Level 1 Noise	Annotation Data Set	Yes	A4
Level 1 RFI	Annotation Data Set	Yes	A5
Map Overlay	Annotation Data Set	Yes	[R-10]
Product Preview	Annotation Data Set	No	N/A
Level 1 Image	Measurement Data Set	No	N/A
Level 1 Quick-look	Measurement Data Set	No	N/A
Level 2 OCN	Measurement Data Set	No	N/A
Level 2 RVL Quick-look	MeasurementDataSet	No	N/A
Level 2 OWI Quick-look	MeasurementDataSet	No	N/A
Level 2 RVL ColorBar	Annotation Data Set	No	N/A
Level 2 RVL ColorBar	Annotation Data Set	No	N/A

The Sentinel-1 representation data sets are defined in Appendix A.

### 3.3.5 Resources

Resources are data that are not physically included in the product but are fundamentally applicable to the generation of the product, such as:

- the L0 input product and all of its applicable resources;
- the software name and version used to process the product; and
- the auxiliary data used to generate the product.

As mentioned above, resources are not included with the product but are referenced by file name, with an entry in the manifest file. The content and format of each resource is governed by its applicable documentation and is beyond the scope of this specification.

All Sentinel-1 L1 and L2 products shall contain – as a minimum – the following resources:

1. This document at the applicable Issue/Revision number;
2. [A-3] at the applicable Issue/Revision number;
3. The identification of the software used to create the product;
4. The name of the input Level-0 products. Before IPF 3.60, only the Level-0 Standard products are annotated. Starting with IPF3.60 and later, three

additional resources are annotated: the “Level-0 Annotation Product”, “Level-0 Calibration Product” and “Level-0 Noise product” (Level 0A/C/N) ;

5. Each auxiliary data file used to generate the product.

## 3.4 Slice Products

Section 3.4.1 introduces the concept of slice products and describes the methods for combining a set of slice products into an assembled product. Sections 3.4.2, 3.4.3, and 3.4.4 describe specifically how information is combined into an assembled product for the manifest file, the measurement data sets and the annotation data sets (respectively).

Note that representation data sets do not require any assembly because they define the structure and content of the data sets and do not themselves include any measurement data or metadata.

### 3.4.1 Overview

L1 output products may be in the form of one of the following:

- An L1 individual scene product that covers a complete L0 segment of data; or
- A set of L1 slice products that collectively cover the same L0 segment of data.

In both cases the output products are fully formatted Sentinel-1 L1 products compliant with the format defined in this specification and the properties of L1 slice products within a set are such that:

- All slices are generated using the same set of processing parameters;
- The image data is continuous in terms of geometry, radiometry and phase; and
- The annotations are coherent in terms of update rate and grid spacing.

These properties allow slice products to be combined to form an assembled L1 product with the same product characteristics that covers the complete L0 segment.

The Sentinel-1 product format has been designed to support individual scene products, slice products and the scenario where a set of slice products is combined into an assembled product.

The following list introduces the three strategies for combining sliced products into an assembled product. These are used throughout the remainder of the document:

- Include – the value of the information is identical for all slices and a single occurrence of the value is copied into the assembled product;

- Merge – the value of the information may differ between slices and a single value must be amalgamated into the assembled product using the values from all slices (the exact method for how this is done is described in the following sections on a field-by-field basis; e.g., averaging, majority polling, summing, etc.); and
- Concatenate – the information is stored in list format and the values from each slice are appended to the appropriate list in the assembled product in Zero Doppler Time (ZDT) ordered sequence and the list count attribute is updated to contain the number of items in the concatenated list.

The following sub-sections provide an example of each assembly strategy.

### 3.4.1.1 Include

The include strategy is used when the value of the field is identical for all slices. This means that without loss of generality the value for the field can be taken from any slice. A practical approach is to always take the value from the first slice. In the example illustrated in Figure 3-3 below, the four fields: *missionId*, *productType*, *polarisation*, and *swath* from the adsHeader DSR are shown for a set of slice products containing  $N$  slices numbered 1 ..  $N$ . The example shows that the values for each field are identical for all slices and are taken from the first slice and included in the assembled product.

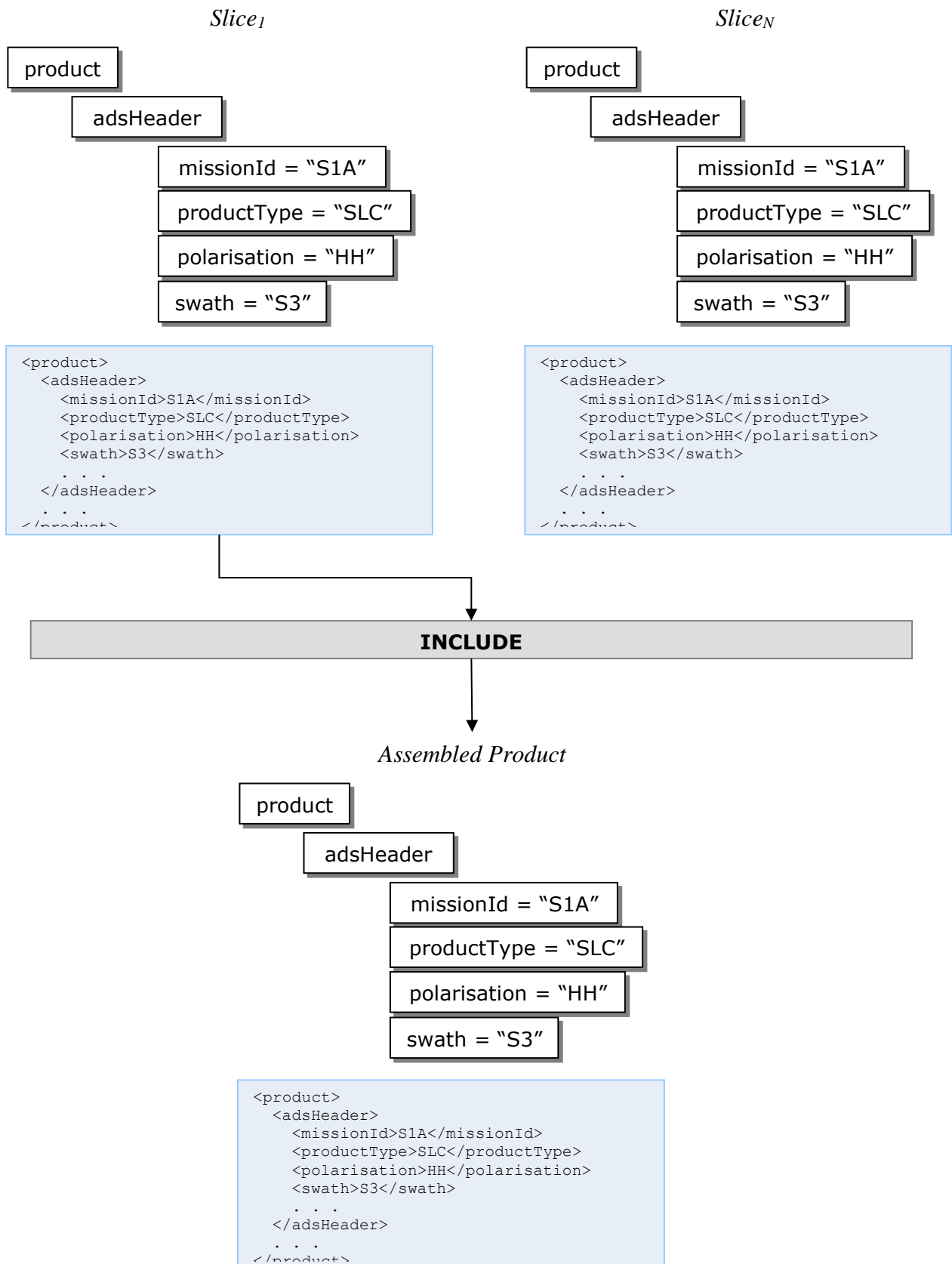
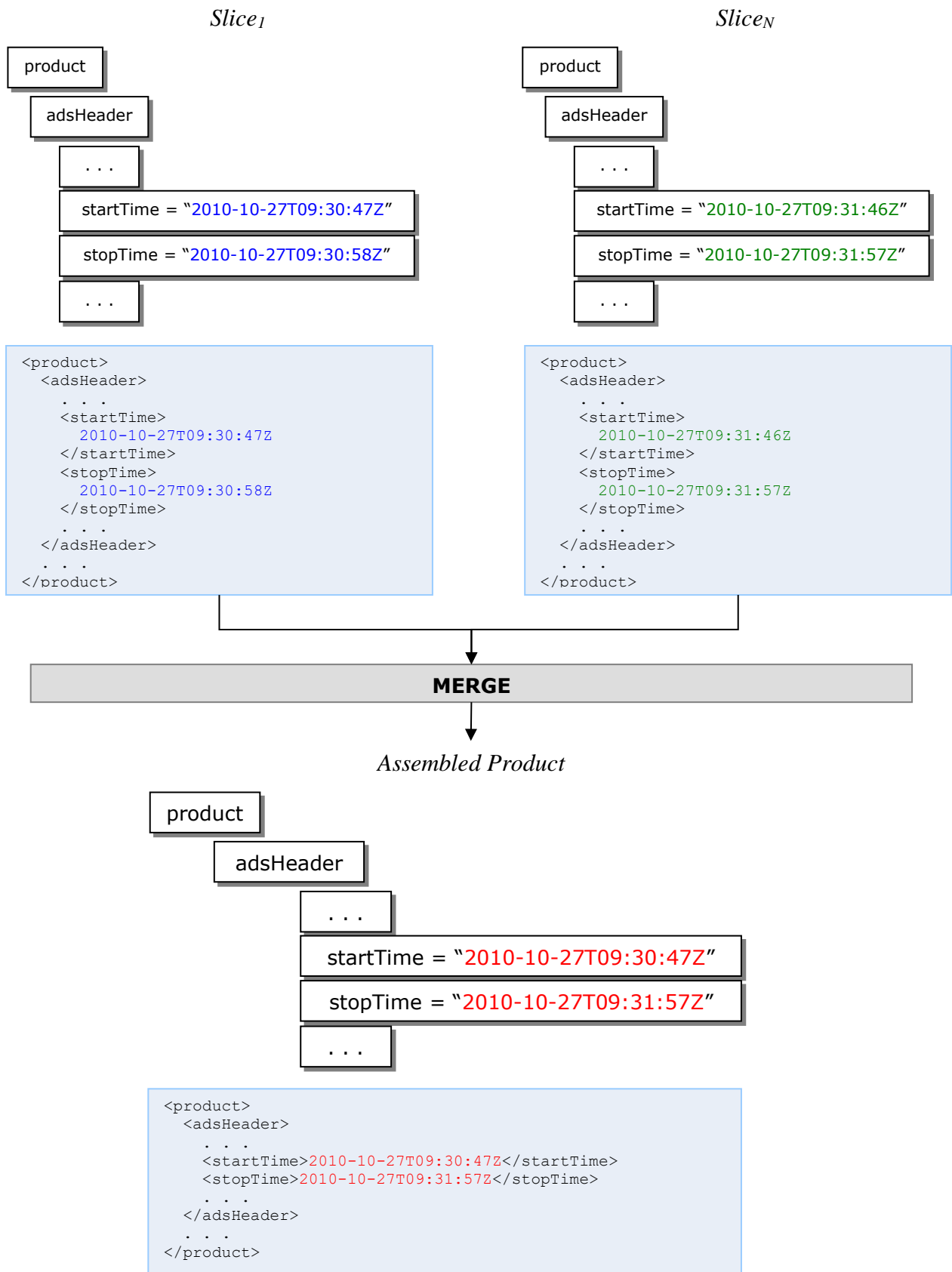

**Figure 3-3 Example of Include Assembly Strategy**

## 3.4.1.2 Merge

The merge strategy is used when the field is unique within the product (i.e. there is only one occurrence of the field within the product) and the value of the field differs between slices. Depending on the nature of the value of the field within the slices, different approaches apply when merging the values for fields. These approaches are explained in the sections below on a field-by-field basis.

In the example illustrated in Figure 3-4, the two fields: *startTime* and *stopTime* from the adsHeader DSR are shown for a set of slice products containing  $N$  slices numbered  $1 .. N$ . These fields are unique within each product and the example shows that the values for each field differ between slices. To merge the *startTime* field, the value is taken from the first slice (*Slice<sub>1</sub>*) and to merge the *stopTime* field, the value is taken from the last slice (*Slice<sub>N</sub>*) as shown in the figure.



**Figure 3-4 Example of Merge Assembly Strategy**



### 3.4.1.3 Concatenate

The concatenate strategy is used when the field or record is contained within a list. This applies to both binary image data as well as XML annotation data.

For imagery data, the binary data from each slice is appended in order and any applicable length (azimuth) dimension is updated to reflect the length of the assembled image. The image width can vary from azimuth line to azimuth line and this must be considered when assembling the final output image. The pixels should be assembled in range time order and padding – zero-fill, for example – should be applied for missing range pixels. A conceptual example of assembling imagery data is illustrated in Figure 3-6.

For XML annotations, lists within a data set are always suffixed with the word “List” and always contain an integer attribute named “count” that identifies the number of items within the list. In general, concatenation is simply appending records to the list in time ordered sequence and updating (merging in a sense) the count attribute to identify the total number of items in the concatenated list. Concatenation of any list within a data set is done at the highest level at which a list exists. For example, if *aList* contains a record named *aRecord* and *aRecord* contains a list named *bList*, concatenation is always performed on *aList*. To ensure data completeness within each slice it is possible that list entries may be duplicated near the time boundaries of consecutive slices. Duplicate list entries will always have the exact same azimuthTime value and can be identified in this way. In terms of handling duplicate entries in the assembled output product, they could be trimmed to one entry in the assembled output product, or they could simply be left as duplicates in the assembled output product. This specification makes no recommendation on the approach for the handling of duplicates; the decision on how to handle duplicate list entries is left to the discretion of the assembler.

In the example illustrated in Figure 3-5 below, the Doppler annotations for the slices are concatenated. For sake of example the data segment is 60 seconds long and divided into 6 slices of 10 seconds each, numbered 1 .. 6. The Doppler centroid estimates are done every 5 seconds creating 2 estimates per slice and a total of 12 estimates over all the slices. For compactness, only the information for the first slice and last slice are shown in the graph. The figure shows the *dcEstimateList* from the first and last slice with two *dcEstimate* records under each. In both cases the value of the count attribute is 2. For the assembled product, the figure shows how the *dcEstimateList* has grown because the *dcEstimate* records from each slice have been added and the value of the count attribute is set to 12.

*Slice<sub>1</sub>*

*Slice<sub>6</sub>*

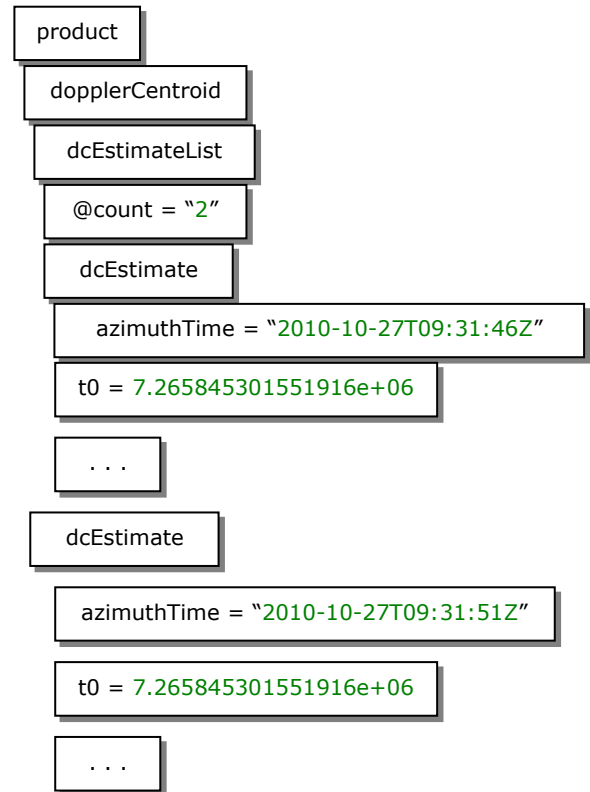
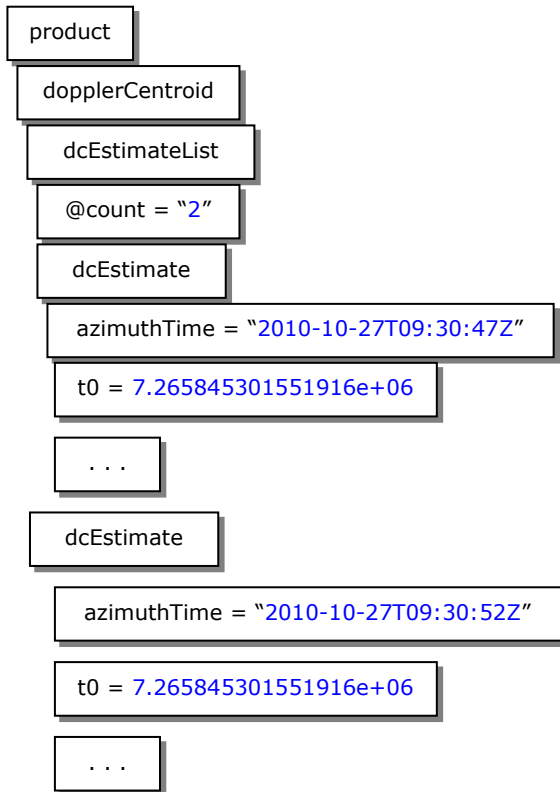

```
<product>
  . . .
  <dopplerCentroid>
  <dcEstimateList count="2">
    <dcEstimate>
      <azimuthTime>
        2010-10-27T09:30:47Z
      </azimuthTime>
      <t0>7.265845301551916e+06</t0>
      . . .
    </dcEstimate>
    <dcEstimate>
      <azimuthTime>
        2010-10-27T09:30:52Z
      </azimuthTime>
      <t0>7.265845301551916e+06</t0>
      . . .
    </dcEstimate>
  </dcEstimateList>
</dopplerCentroid>
. . .
</product>
```

```
<product>
  . . .
  <dopplerCentroid>
  <dcEstimateList count="2">
    <dcEstimate>
      <azimuthTime>
        2010-10-27T09:31:46Z
      </azimuthTime>
      <t0>7.265845301551916e+06</t0>
      . . .
    </dcEstimate>
    <dcBlock>
      <azimuthTime>
        2010-10-27T09:31:51Z
      </azimuthTime>
      <t0>7.265845301551916e+06</t0>
      . . .
    </dcBlock>
  </dcEstimateList>
</dopplerCentroid>
. . .
</product>
```

**CONCATENATE**

## Assembled Product



Figure 3-5 Example of Concatenate Assembly Strategy

## 3.4.2 Manifest File

Table 3-6 describes the assembly strategy on a field-by-field basis for the Manifest file at the granularity needed to create an assembled product. Note that only fields with a variable value are mentioned in the table. The strategy for fields with a constant value is always “include” so they have been omitted from the table.

**Table 3-6 Assembly of the Sentinel-1 Manifest File**

Data Set Record	Assembly Strategy	Reference
Information Package Map	<p>The information package map is assembled as follows:</p> <ul style="list-style-type: none"> <li>• All metadata content units (where <i>unitType</i> = “Metadata Unit”) are included; and, <ul style="list-style-type: none"> <li>• All sub-dataObjectPointer elements are updated (merged) so their dataObjectID reflects the dataObjectIDs of the dataObjects in the assembled product; and,</li> </ul> </li> <li>• All measurement content units (where <i>unitType</i> = “Measurement Data Unit”) are merged as follows: <ul style="list-style-type: none"> <li>• All dmdID attributes are updated to reflect the metadataObject IDs of the metadataObjects in the assembled product; and</li> <li>• All dataObjectPointer elements are updated so their dataObjectID reflects the dataObjectIDs of the dataObjects in the assembled product.</li> </ul> </li> </ul>	6.1.1
Metadata Section	<p>The metadata section is assembled as follows:</p> <ul style="list-style-type: none"> <li>• metadataObject’s are merged as follows: <ul style="list-style-type: none"> <li>• The dataObjectPointer elements are updated so their dataObjectID reflect the dataObjectIDs of the dataObjects in the assembled product; and,</li> <li>• The ID attribute is updated so that it reflects the dataObjectsIDs of the dataObjects in the assembled product</li> </ul> </li> <li>• metadataWrap elements are merged as follows: <ul style="list-style-type: none"> <li>• The processing element is assembled using one of the following proposed methods: <ul style="list-style-type: none"> <li>• All fields from the processing element are included except the start and stop attributes which are merged as follows: <ul style="list-style-type: none"> <li>• start is set to the processing start time of the first slice;</li> <li>• stop is set to the processing stop time of the last slice;</li> </ul> </li> <li>• Or, a new top-level processing element is created with the start and stop attributes set to the start time and stop time of the assembled product. The top-level processing element from each slice used in the generation of the assembled product is added as a resource under the top-level processing element of the assembled product;</li> </ul> </li> <li>• The fields from the acquisitionPeriod element are merged as follows:</li> </ul> </li> </ul>	6.1.2

Data Set Record	Assembly Strategy	Reference
	<ul style="list-style-type: none"> <li>• The startTime and startTimeANX attributes are set to their respective times from the first slice;</li> <li>• The stopTime and stopTimeANX attributes are set to their respective times from the last slice;</li> <li>• All fields from the platform element are included;</li> <li>• The fields from the measurementOrbitReference element are merged as follows:               <ul style="list-style-type: none"> <li>• For the orbitNumber element the start attribute is set to the value from the first slice and the stop attribute is set to the value from the last slice;</li> <li>• For the relativeOrbitNumber element the start attribute is set to the value from the first slice and the stop attribute is set to the value from the last slice;</li> <li>• The value of the cycleNumber element is set to the value from the last slice;</li> <li>• The value of the phaseIdentifier element is set to the value from the last slice;</li> <li>• The value of the pass element is set to the value from the first slice;</li> <li>• The value of the ascendingNodeTime is set to the value from the first slice;</li> </ul> </li> <li>• The measurementFrameSet element is merged by updating the coordinates element so that the values represent the coordinates of the assembled image.</li> <li>• All the fields in the generalProductInformation element are included except for the productComposition and sliceProductFlag. The productComposition is set to “Assembled” and the sliceProductFlag is updated so that it is set to false and the following elements are then omitted:               <ul style="list-style-type: none"> <li>• segmentStartTime;</li> <li>• sliceNumber;</li> <li>• totalSlices; and</li> </ul> </li> <li>• metadataReference elements (RDS) are included.</li> </ul>	
Data Object Section	<p>The data object section is assembled by merging each dataObject as follows:</p> <ul style="list-style-type: none"> <li>• The ID attribute may be merged by updating its value based on filename of the object within the assembled product;</li> <li>• The href attribute of the byteStream element is merged by updating its value so that it points to the filename of the object within the assembled product;</li> <li>• The checksum element of the byteStream element is merged by recalculating the checksum on the object file within the assembled product;</li> <li>• The size attribute of the byteStream element is merged by setting its value to the size of the object file within the assembled product.</li> </ul>	6.1.3

### 3.4.3 Measurement Data Sets

Table 3-7 describes the assembly strategy on a field-by-field basis for the L1 image MDS at the granularity needed to create an assembled product. Note that only fields with a variable value are mentioned in the table. The strategy for fields with a constant value is always “include” so they have been omitted from the table. The reference column in the table indicates the section where the field is described. Figure 3-6 illustrates the process of assembling the information in an L1 image MDS.

**Table 3-7 Assembly of the L1 Measurement Data Sets**

Data Set Name	Assembly Strategy	Reference
L1 Image	TIFF/GeoTIFF header tags are included and merged. Details are provided in Table 3-8.  Measurement (image) data is concatenated.	6.2.1
Quick look Image	The PNG header is merged by setting the Width field to the maximum range extent across all the slices and summing the Height field for all slices. All other header fields are included.  Measurement (image) data is concatenated.  Note: For IW and EW SLC images, the Quick-Look image for a slice will contain black fill at the start and end of the image that varies for each swath. This is due to the fact that the SLCs consist of staggered bursts from multiple swaths, so that the edges of the Quick-Look image of a slice must be padded out so that all swaths start and end at the same line. As a result, the concatenated Quick-Look images from IW and EW SLC slices will also contain extra padding at slice boundaries, and the resulting Quick-Look image will be longer than the concatenated full resolution Quick-Look image. In addition, if a KML bounding box is used to overlay the IW/EW Quick-Look on a map, due to the mismatch in image dimensions and the physical geolocation, the image will appear “squished” in the overlay.  This only applies to IW and EW SLC Quick-Look images, it does not apply to other modes or to other IW and EW products.	6.2.2
L2 Ocean	Not Applicable. The L2 OCN product is generated only from an individual scene or slice input L1 product and assembled products are not relevant to the generation of L2 products. The combination of data sets within L2 products is beyond the scope of this specification.	6.2.3
L2 OWI Quick-look & L2 RVL Quick-look	The PNG header is merged by setting the Width field to the maximum range extent across all the slices and summing the Height field for all slices. All other header fields are included.  Measurement (image) data is concatenated	6.2.4

Table 3-8 Assembly of L1 Image MDS TIFF/GeoTIFF Information

Field Name	Strategy	Details	Reference
ImageWidth	Merge	The value of this field is merged by considering the minimum range sample across all slices, $Range_{min}$ and the maximum range sample across all slices, $Range_{max}$ .  $ImageWidth = Range_{max} - Range_{min}$	6.2.1
ImageLength	Merge	The value of this field is merged by summing the ImageLength field from all slices.  $ImageLength = \sum_{i=1}^N Slice_i^{ImageLength}$ Where N equals the total number of slices.	6.2.2
BitsPerSample	Include	N/A	6.2.2
Compression	Include	N/A	6.2.2
PhotometricInterpretation	Include	N/A	6.2.2
ImageDescription	Include	N/A	6.2.2
StripOffsets	Merge	This field is merged by recalculating the StripOffsets of each slice relative to the previous slice.	6.2.2
Orientation	Include	N/A	6.2.2
SamplesPerPixel	Include	N/A	6.2.2
RowsPerStrip	Include	N/A	6.2.2
StripByteCounts	Merge	This field is merged by recalculating the StripByteCounts for each strip in the assembled image.	6.2.2
Planar Configuration	Include	N/A	6.2.2
Software	Merge	Optional. This field contains a string identifying the Sentinel-1 IPF as the software that created the image. This field could optionally be updated to include the software used to create the assembled product.	6.2.2
DateTime	Merge	This field is merged by setting the value to the date and time the assembled image was created.	6.2.2
SampleFormat	Include	N/A	6.2.2
ModelTiePointTag	Merge	The value of each line field must be merged for each tie point by recalculating the line number relative to the total number of lines in all preceding slices:  $line_i^N = \sum_{x=1}^{N-1} Slice_{numLines}^x + Slice_i^N$ Where: $N = \text{Slice number}$	6.2.2



# Sentinel-1

Ref: S1-RS-MDA-52-7441  
 MPC Nom: DI-MPC-PB  
 MPC Ref: MPC-0240  
 Issue/Revision: 3/12  
 Date: 19/09/2022

Field Name	Strategy	Details	Reference
		$i = \text{Line number relative to } N$ $numLines = \text{Total number of lines in slice}$	
GeoKeyDirectoryTag	Include	N/A	6.2.2
GeoDoubleParamsTag	Include	N/A	6.2.2
GeoAsciiParamsTag	Include	N/A	6.2.2
GTModelTypeGeoKey	Include	N/A	6.2.2
GTRasterTypeGeoKey	Include	N/A	6.2.2
GTCitationGeoKey	Include	N/A	6.2.2
GeographicTypeGeoKey	Include	N/A	6.2.2
GeogCitationGeoKey	Include	N/A	6.2.2
GeogLinearUnitsGeoKey	Include	N/A	6.2.2
GeogAngularUnitsGeoKey	Include	N/A	6.2.2
GeogEllipsoidGeoKey	Include	N/A	6.2.2
GeogSemiMajorAxisGeoKey	Include	N/A	6.2.2
GeogSemiMinorAxisGeoKey	Include	N/A	6.2.2
GeogInvFlatteningGeoKey	Include	N/A	6.2.2



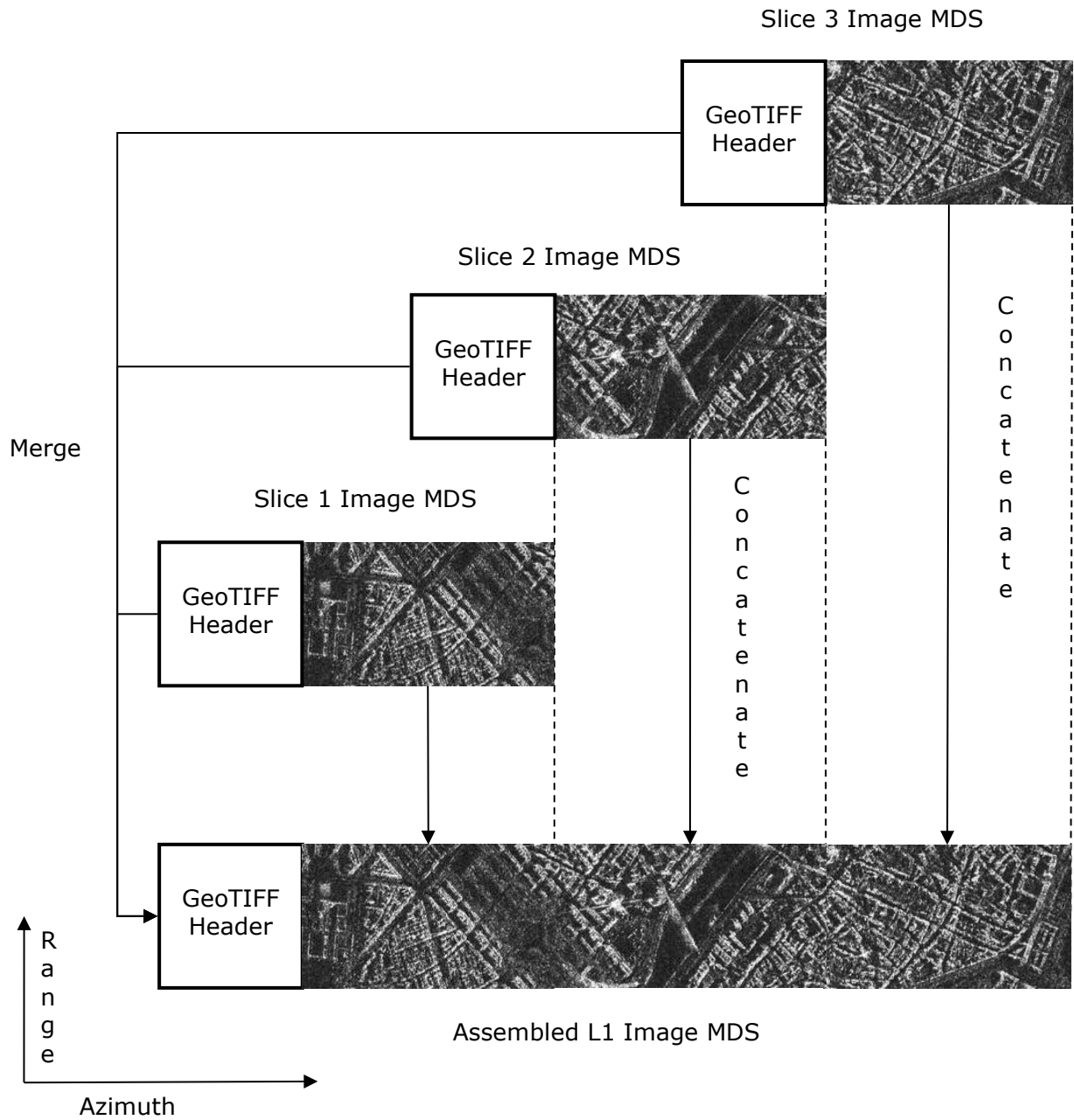

**Figure 3-6 Assembly of a L1 Image MDS**

## 3.4.4 Annotation Data Sets

Table 3-9 describes how to combine each type of L1 ADS into an assembled product. The reference column in the tables indicates the sections where the data set is defined.

**Table 3-9 Assembly of the L1 Annotation Data Sets**

Data Set Name	Assembly Strategy	References
Level 1 Product Annotation	The Level 1 Product Annotation data set requires inclusion, merging and concatenation. A breakdown of the general merging and concatenation strategy by record for this data set is presented in Table 3-10.	6.3.1 A2
Level 1 Calibration	<p>The Calibration ADS is assembled as follows:</p> <ul style="list-style-type: none"> <li>• The values for the fields in the ADS header are included except for the values of the startTime and stopTime fields, which are merged as follows:               <ul style="list-style-type: none"> <li>• startTime is merged by taking the value of the field from the first slice.</li> <li>• stopTime is merged by taking the value of the field from the last slice;</li> </ul> </li> <li>• The values for the fields in the calibrationInformation record are included; and,</li> <li>• The list of calibration annotations contained in the calibrationVectorList is concatenated and the count attribute is updated to contain the number of calibrationVector records in the concatenated list.</li> <li>• The line element in each calibrationVector record is updated to reflect the line in the assembled image.</li> </ul>	6.3.2 A3

Data Set Name	Assembly Strategy	References
Level 1 Noise	<p>The Noise ADS is assembled as follows:</p> <ul style="list-style-type: none"> <li>• The values for the fields in the ADS header are included except for the values of the startTime and stopTime fields, which are merged as follows: <ul style="list-style-type: none"> <li>• startTime is merged by taking the value of the field from the first slice.</li> <li>• stopTime is merged by taking the value of the field from the last slice; and,</li> </ul> </li> <li>• The list of range thermal annotations contained in the noiseRangeVectorList is concatenated and the count attribute is updated to contain the number of noiseRangeVector records in the concatenated list.</li> <li>• The line element in each noiseRangeVector record is updated to reflect the line in the assembled image.</li> <li>• The list of azimuth thermal annotations contained in the noiseAzimuthVectorList is concatenated and the count attribute is updated to contain the number of noiseAzimuthVector records in the concatenated list.</li> <li>• The firstAzimuthLine, lastAzimuthLine and line elements in each noiseAzimuthVector are updated to reflect the line in the assembled image.</li> </ul>	<p>6.3.3 A4</p>
Level 1 RFI	<p>The RFI ADS is assembled as follows:</p> <ul style="list-style-type: none"> <li>• The values for the fields in the ADS header are included except for the values of the startTime and stopTime fields, which are merged as follows: <ul style="list-style-type: none"> <li>• startTime is merged by taking the value of the field from the first slice.</li> <li>• stopTime is merged by taking the value of the field from the last slice; and,</li> </ul> </li> <li>• The rfiMitigationApplied field is included;</li> <li>• The list of RFI detections from the noise echoes rfiDetectionFromNoiseReportList is concatenated and the count attribute is updated to contain the number of rfiDetectionFromNoiseReport records in the concatenated list;</li> <li>• The list of RFI burst reports rfiBurstReportList is concatenated and the count attribute is updated to contain the number of rfiBurstReport records in the concatenated list.</li> </ul>	<p>6.3.4</p>
Map Overlay	<p>The values for all fields in the Map Overlay data set are included except for the coordinates elements of the gx:LatLonQuad element; these are merged by updating their values so that they represent the coordinates of the assembled image.</p>	<p>6.3.4</p>
Product Preview	<p>The values for all fields in the Product Preview data set are merged by setting the product name and data set file names to the corresponding names in the assembled product.</p>	<p>6.3.6</p>

**Table 3-10 Assembly of the Level 1 Product Annotation ADS**

Data Set Record	Assembly Strategy	Reference
ADS Header	<p>The values for the fields in the ADS header are included except for the values of the start<code>Time</code> and stop<code>Time</code> fields, which are merged as follows:</p> <ul style="list-style-type: none"> <li>start<code>Time</code> is merged by taking the value of the field from the first slice.</li> <li>stop<code>Time</code> is merged by taking the value of the field from the last slice.</li> </ul>	Table 3-20
Quality Information	The list of quality annotations contained in the quality <code>DataList</code> element is concatenated and the count attribute is updated to contain the number of quality <code>Data</code> records in the concatenated list.	6.3.1.1
General Annotation	The product <code>Information</code> sub-record contains single value fields that are merged and included. All other sub-records contain lists which are concatenated. Details are presented in Table 3-11.	6.3.1.2
Image Annotation	This DSR contains two records which contain only single value fields. The fields in the image <code>Information</code> record are included and merged and all the fields for the processing <code>Information</code> record are included; except for the input <code>DimensionsList</code> record, which is concatenated. Details are presented in Table 3-12.	0
Doppler Centroid	The list of Doppler centroid annotations contained in the dc <code>BlockList</code> element is concatenated and the count attribute is updated to contain the number of dc <code>Block</code> records in the concatenated list.	6.3.1.4
Antenna Pattern	The list of antenna pattern annotations contained in the antenna <code>PatternList</code> element is concatenated and the count attribute is updated to contain the number of antenna <code>Pattern</code> records in the concatenated list.	6.3.1.5
Swath Timing	<p>The list of swath timing annotations contained in the burst<code>List</code> element is concatenated and the count attribute is updated to contain the number of burst records in the concatenated list.</p> <p>In addition to concatenation, each byte<code>Offset</code> field must be merged to contain the correct byte offset by recalculating each byte<code>Offset</code> relative to all preceding bursts within the assembled image:</p> $byteOffset_i^N = Slice_{lastByteOffset}^{N-1} + Slice_i^N$ <p>Where:</p> <ul style="list-style-type: none"> <li><math>N</math> = Slice number</li> <li><math>i</math> = Byte offset relative to <math>N</math></li> <li><math>lastByteOffset</math> = Largest (last) byte offset from the previous slice</li> </ul>	6.3.1.6

Data Set Record	Assembly Strategy	Reference
Geolocation Grid	<p>The list of geolocation grid points contained in the geolocationGridPointList element is concatenated and the count attribute is updated to contain the number of geolocationGridPoint records in the concatenated list.</p> <p>In addition to the concatenation, the value of the line field must be merged for each grid point by recalculating the line number relative to the total number of lines in all preceding slices:</p> $line_i^N = \sum_{x=1}^{N-1} Slice_{numLines}^x + Slice_i^N$ <p>Where:</p> <p><math>N</math> = Slice number  <math>i</math> = Line number relative to <math>N</math>  <math>numLines</math> = Total number of lines in slice</p>	6.3.1.7
Coordinate Conversion	<p>The list of coordinate conversion annotations contained in the coordinateConversionList is concatenated and the count attribute is updated to contain the number of coordinateConversion records in the concatenated list.</p>	6.3.1.8
Swath Merging	<p>The lists of swath merging annotations are concatenated. There is a swathBoundsList for each swath. The list of swath merging annotations contained in each swathBoundsList is concatenated and the count attribute for each is updated to contain the number of swathBounds records in the concatenated list.</p>	6.3.1.9

**Table 3-11 Assembly of the L1 General Annotation ADSR**

Field Path	
Strategy	Details
/product/generalAnnotation/productInformation/pass	
Merge	Use the pass field from the first slice in the product.
/product/generalAnnotation/productInformation/timelinessCategory	
Include	N/A
/product/generalAnnotation/productInformation/platformHeading	
Merge	The platformHeading field is merged recalculating the platform heading mid-acquisition (azimuth direction) for the assembled product.
/product/generalAnnotation/productInformation/projection	
Include	N/A
/product/generalAnnotation/productInformation/rangeSamplingRate	
Include	N/A

Field Path	
Strategy	Details
/product/generalAnnotation/productInformation/radarFrequency Include	N/A
/product/generalAnnotation/productInformation/azimuthSteeringRate Include	N/A
/product/generalAnnotation/downlinkInformationList Concatenate	The list of downlink information annotations contained in the downlinkInformationList element is concatenated and the count attribute is updated to contain the number of downlinkInformation records in the concatenated list.
/product/generalAnnotation/orbitList Concatenate	The list of orbit annotations contained in the orbitList element is concatenated and the count attribute is updated to contain the number of orbit records in the concatenated list.
/product/generalAnnotation/attitudeList Concatenate	The list of downlink information annotations contained in the attitudeList element is concatenated and the count attribute is updated to contain the number of attitude records in the concatenated list.
/product/generalAnnotation/replicaInformation/replicaInformationList Concatenate	The list of replicaInformation annotations contained in the replicaInformationList element is concatenated and the count attribute is updated to contain the number of replicaInformation records in the concatenated list.
/product/generalAnnotation/noiseList Concatenate	The list of noise measurement annotations contained in the noiseList element is concatenated and the count attribute is updated to contain the number of noise records in the concatenated list.
/product/generalAnnotation/terrainHeightList Concatenate	The list of terrain height annotations contained in the terrainHeightList element is concatenated and the count attribute is updated to contain the number of terrainHeight records in the concatenated list.
/product/generalAnnotation/azimuthFmRateList Concatenate	The list of azimuth FM rate annotations contained in the azimuthFmRateList element is concatenated and the count attribute is updated to contain the number of azimuthFmRate records in the concatenated list.

**Table 3-12 Assembly of the L1 Image Annotation ADSR**

Field Path	
Strategy	Details
/product/imageAnnotation/imageInformation/productFirstLineUtcTime Merge	The productFirstLineUtcTime field is merged by using the value of this field from the first slice.

Field Path	
Strategy	Details
/product/imageAnnotation/imageInformation/productLastLineUtcTime	
Merge	The productLastLineUtcTime field is merged by using the value of this field from the last slice.
/product/imageAnnotation/imageInformation/ascendingNodeTime	
Merge	The ascendingNodeTime field is merged by using the value of this field from the first slice.
/product/generalAnnotation/imageInformation/anchorTime	
Include	The anchorTime value will be the same in every slice
/product/generalAnnotation/imageInformation/productComposition	
Merge	The productComposition field is set to “Assembled” for the final product (the input slice productComposition fields should be set to “Slice”).
/product/generalAnnotation/imageInformation/sliceNumber	
Merge	The sliceNumber field is set to 0.
/product/generalAnnotation/imageInformation/sliceList	
Include	N/A
/product/generalAnnotation/imageInformation/slantRangeTime	
Include	The slantRangeTime value will be the same in every slice
/product/imageAnnotation/imageInformation/pixelValue	
Include	N/A
/product/imageAnnotation/imageInformation/outputPixels	
Include	N/A
/product/imageAnnotation/imageInformation/rangePixelSpacing	
Include	N/A
/product/imageAnnotation/imageInformation/azimuthPixelSpacing	
Merge	The value of the azimuthPixelSpacing field is merged by calculating the average value of the azimuthPixelSpacing field across all slices.
/product/imageAnnotation/imageInformation/azimuthTimeInterval	
Include	N/A
/product/imageAnnotation/imageInformation/azimuthFrequency	
Include	N/A
/product/imageAnnotation/imageInformation/numberOfSamples	
Merge	The value of this field is merged by considering the minimum range sample across all slices, $Range_{min}$ and the maximum range sample across all slices, $Range_{max}$ :  $ImageWidth = Range_{max} - Range_{min}$

Field Path	
Strategy	Details
/product/imageAnnotation/imageInformation/numberOfLines Merge	The value of this field is merged by summing the numberOfLines field from all slices.  $numberOfLines = \sum_{i=1}^N Slice_i^{numberOfLines}$ Where N equals the total number of slices.
/product/imageAnnotation/imageInformation/zeroDopMinusAcqTime Include	N/A
/product/imageAnnotation/imageInformation/incidenceAngleMidSwath Include	N/A
/product/imageAnnotation/imageInformation/imageStatistics/outputDataMean Merge	The value of the outputDataMean field is merged by recalculating the mean of the data in the assembled output image.
/product/imageAnnotation/imageInformation/imageStatistics/outputDataStdDev Merge	The value of the outputDataStdDev field is merged by recalculating the standard deviation of the data in the assembled output image.
/product/imageAnnotation/processingInformation Include	The values for all fields within the processingInformation record are identical among all slices and therefore included, except those fields noted below.
/product/imageAnnotation/processingInformation/inputDimensionsList Concatenate	The list of input dimension annotations contained in the inputDimensionsList element is concatenated and the count attribute is updated to contain the number of inputDimensions records in the concatenated list.

## 3.5 Product Naming

This section defines the naming convention for Sentinel-1 products. Consideration has been made with respect to the ESA Sentinel-1 Products Naming Convention described in [R-9]. This document has been created specifically to meet the product naming needs of the Sentinel-1 mission.

### 3.5.1 Product

This section defines the naming standard for the top-level Sentinel-1 product folder. The top-level Sentinel-1 product folder name is composed of upper-case alphanumeric characters separated by an underscore “\_”. Figure 3-7 defines the naming standard for Sentinel-1 products. Table 3-13 defines the naming elements and their range and is used throughout the remainder of this document as the standard for naming Sentinel-1 product folders.

For assembled products, the product name is updated as follows:



- The value of each naming element is included, except for:
  - Start date/time which is merged by using the value from the first slice;
  - Stop date/time which is merged by using the value from the last slice; and,
  - Product unique identifier which is merged by recalculating the CRC-16 checksum on the assembled manifest file.

Note that ASAR options are only valid for ASAR offline test products and will not be available operationally.

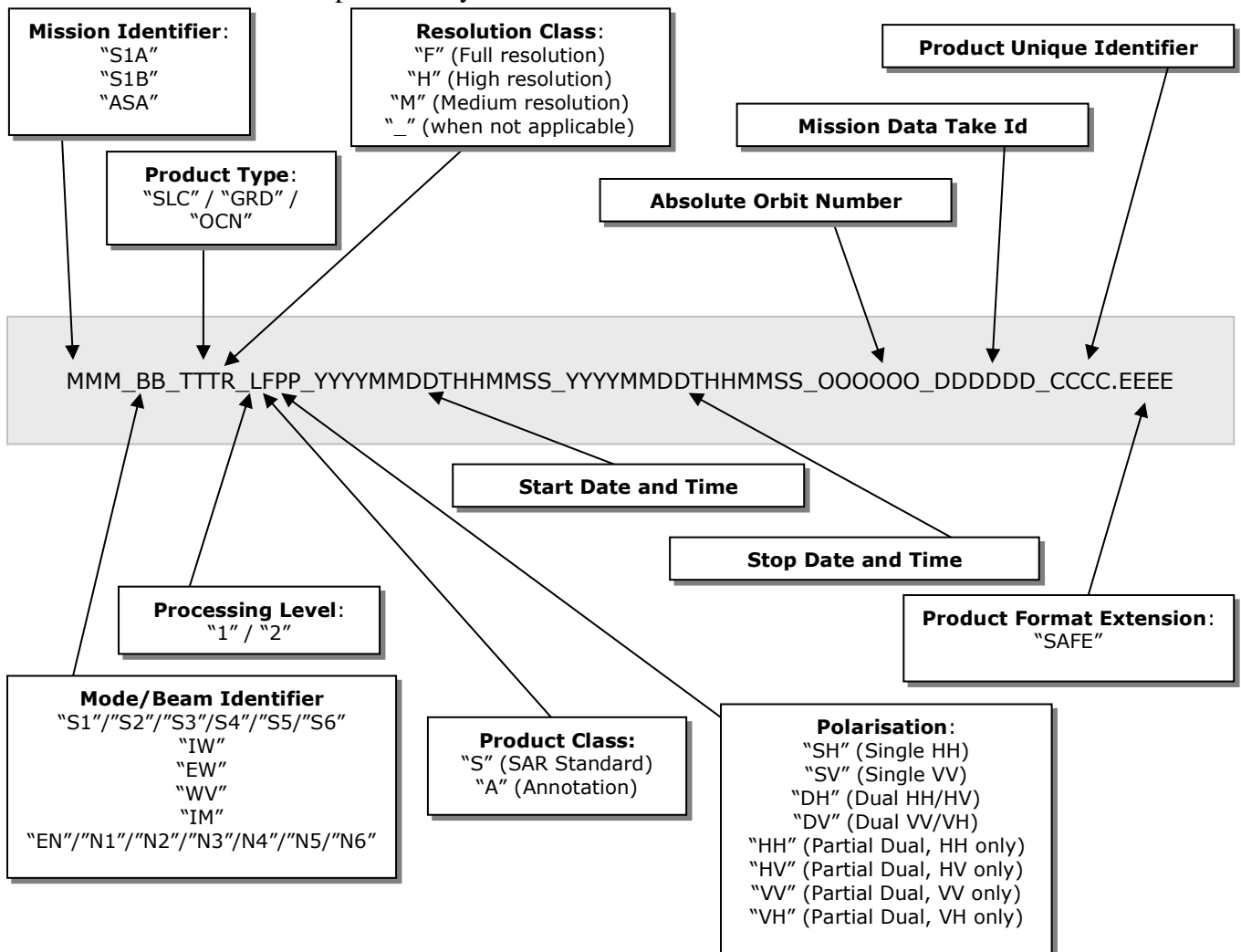

Figure 3-7 Sentinel-1 Product Naming Convention

**Table 3-13 Sentinel-1 Product Naming Elements**

Name Element Pattern	Name Element Description	Name Element Range
MMM	Mission identifier. The S1A option is used for products produced for the Sentinel-1A instrument and the S1B is used for products produced for the Sentinel-1B instrument. The ASA option is used for products produced from the ENVISAT ASAR instrument.	S1A, S1B, ASA
BB	Mode/beam identifier. The S1-S6 beams apply to SM products, and IW, EW and WV identifiers apply to products from the respective modes. The EN and N1-N6 beams apply to the notch acquisition modes. The IM and WV modes apply to ASAR IM and WV products respectively.	S1, S2, S3, S4, S5, S6, IW, EW, WV, EN, N1, N2, N3, N4, N5, N6, IM
TTT	Product type.	SLC, GRD, OCN
R	Resolution class.	F (Full resolution), H (High resolution), M (Medium resolution), _ (underscore: Not applicable to the current product type. Used for SLC and OCN.)
L	Processing level.	1, 2
F	Product class.	S (SAR Standard), A (Annotation product).
PP	Polarisation.	SH (Single HH polarisation), SV (Single VV polarisation), DH (Dual HH/HV polarisation), DV (Dual VV/VH polarisation), HH (Partial Dual polarisation, HH only), HV (Partial Dual polarisation, HV only), VV (Partial Dual polarisation, VV only), VH (Partial Dual polarisation, VH only)
YYYYMMDDTHHMSS	Product start or stop date and time.	Fourteen digits representing the start date and time separated by the character T.
OOOOOO	Absolute orbit number at product start time.	000001-999999
DDDDDD	Mission data take identifier.	000001-FFFFFF (000000 for ASAR)
CCCC	Product unique identifier. A hexadecimal string generated by computing CRC-16 on the manifest file. The CRC-16 algorithm used to compute the unique identifier is CRC-CCITT (0xFFFF).	0000-FFFF
EEEE	Product format extension.	SAFE

## 3.5.2 Manifest File

The name of the manifest file included in all products is:

manifest.safe

## 3.5.3 Data Sets

This section defines the naming standard for all data set files within a Sentinel-1 product. Sentinel-1 product data sets are composed of lower-case alphanumeric characters separated by a hyphen “-”. Table 3-14 defines the naming elements and their range and is used throughout the remainder of this document as the standard for naming Sentinel-1 product data sets.

In the case of assembled products, the data set names are updated as follows:

- The value of each naming element is included, except for:
  - Sensing start date/time which is merged by using the value from the first slice; and
  - Sensing stop date/time which is merged by using the value from the last slice.

Note that ASAR options are only valid for ASAR offline test products and will not be available operationally.

**Table 3-14 Sentinel-1 Data Set Naming Elements**

Name Element Pattern	Name Element Description	Name Element Range
mmm	Mission identifier. The s1a option is used for products produced for the Sentinel-1A instrument and the s1b is used for products produced for the Sentinel-1B instrument. The asa option is used for products produced from the ENVISAT ASAR instrument.	s1a, s1b, asa
sss	Swath identifier (up to 3 lower case alphanumeric characters). The s1-s6 swaths apply to SM products, the iw and iw1-3 swaths apply to IW products (iw is used for detected IW products where the 3 swaths are merged into one image), the ew and ew1-5 swaths apply to EW products (ew is used for detected EW products where the 5 swaths are merged into one image), and the wv1-2 swaths apply to WV products. The en and n1-n6 swaths apply to the notch acquisition modes. The is1-is7 swaths apply to ASAR IM and WV products.	s1, s2, s3, s4, s5, s6, iw, iw1, iw2, iw3, ew, ew1, ew2, ew3, ew4, ew5, wv1, wv2, en, n1, n2, n3, n4, n5, n6, is1, is2, is3, is4, is5, is6, is7
ttt	Product type	slc, grd, ocn
pp	Polarisation	hh (Single HH polarisation), hv (Single HV polarisation), vv (Single VV polarisation), vh (Single VH polarisation)
nnn	Image number. For WV products the image number is used to distinguish between vignettes. For SM, IW and EW modes the image number is still used but refers instead to each swath and polarisation combination (known as the “channel”) of the data.	001-999 See notes <sup>2345</sup> below.
yyyymmddthmmss	Product start or stop date and time.	Fourteen digits representing the date and time separated by the character t <sup>6</sup> .
ooooo	Absolute orbit number at product start time.	000001-999999
dddddd	Mission data take id. For Level 2 measurement data, this field can be either in lower or upper case	000001-ffffff or 000001-FFFFFF

<sup>2</sup> WV mode has an image number for each vignette. For a WV product with 105 vignettes, 105 images exist numbered in time ascending order from 001 through 105.

<sup>3</sup> SM single polarisation products have one channel numbered 001. SM dual polarisation products have two channels numbered 001 and 002 in the order they are processed by the IPF.

<sup>4</sup> IW single polarisation products have three channels numbered 001 – 003. IW dual polarisation products have six channels numbered 001 – 006 in the order they are processed by the IPF.

<sup>5</sup> EW single polarisation products have five channels numbered 001 – 005. EW dual polarisation products have ten channels numbered 001 – 010 in the order they are processed by the IPF.

<sup>6</sup> For IW and EW SLC products the start and stop times are different for each MDS.

Name Element Pattern	Name Element Description	Name Element Range
eeee	File extension	html, kml, tiff, xml, xsd, nc, png

### 3.5.3.1 Measurement Data Sets

Table 3-15 defines the naming convention for all measurement data sets used within Sentinel-1 products.

**Table 3-15 Measurement Data Set Naming Convention for Sentinel-1**

MDS Type	Naming Convention
L1 Image and L2 Measurement	mmm-sss-ttt-pp-yyyymmddthhmmss-yyyymmddthhmmss-ooooo-ddddd-nnn.eeee
Quick look	quick-look.png
L2 Quicklooks	quick-look-l2-owi.png quick-look-l2-rvl.png

### 3.5.3.2 Annotation Data Sets

Table 3-16 defines the naming convention for all annotation data sets used within Sentinel-1 products.

**Table 3-16 Annotation Data Set Naming Convention for Sentinel-1**

ADS Type	Naming Convention
Level 1 Product Annotation	mmm-sss-ttt-pp-yyyymmddthhmmss-yyyymmddthhmmss-ooooo-ddddd-nnn.xml
Level 1 Calibration	calibration-mmm-sss-ttt-pp-yyyymmddthhmmss-yyyymmddthhmmss-ooooo-ddddd-nnn.xml
Level 1 Noise	noise-mmm-sss-ttt-pp-yyyymmddthhmmss-yyyymmddthhmmss-ooooo-ddddd-nnn.xml
Level 1 RFI	rfi-mmm-sss-ttt-pp-yyyymmddthhmmss-yyyymmddthhmmss-ooooo-ddddd-nnn.xml
Map Overlay	map-overlay.kml
Product Preview	product-preview.html
ColorBar	owi-colorbar.png rvl-colorbar.png

### 3.5.3.3 Representation Data Sets

Table 3-17 defines the names of all representation data sets used within Sentinel-1 products.

**Table 3-17 Representation Data Set Naming Convention for Sentinel-1**

RDS Type	Naming Convention
Sentinel 1 Object Types	s1-object-types.xsd
Level 1 Product	s1-level-1-product.xsd
Level 1 Calibration	s1-level-1-calibration.xsd
Level 1 Noise	s1-level-1-noise.xsd
Level 1 RFI	s1-level-1-rfi.xsd

## 3.6 Product Conventions

This section describes applicable product conventions.

### 3.6.1 Decisions

- GeoTIFF imagery will be stored in native byte endian format, nominally little endian (byte order is specified in the TIFF format).
- Product annotations will use standard SI units whenever possible.
- Attributes should be defined using only the following types from the XML Schema namespace [<http://www.w3.org/2001/XMLSchema>]:
  - long
  - int
  - short
  - byte
  - unsignedLong
  - unsignedInt
  - unsignedShort
  - unsignedByte
  - string
- Where ever possible elements should be defined using the primitive data types described in Section 3.6.3 for the Sentinel-1 namespaces:
  - s1sar: <http://www.esa.int/safe/sentinel-1.0/sentinel-1/sar>
  - s1sarl1: <http://www.esa.int/safe/sentinel-1.0/sentinel-1/sar/level-1>

- s1sar12: <http://www.esa.int/safe/sentinel-1.0/sentinel-1/sar/level-2>

## 3.6.2 Content Table Conventions

This specification presents the contents of S1 product structures as using tables detailing the content. In order to help understand the information contained in these tables the columns present in each table and their meaning are presented in Table 3-18.

**Table 3-18 Product Data Content Table Column Descriptions**

Column Name	Description
Name	<p>Defines the name of the element or attribute.</p> <p>Elements are displayed in normal font.</p> <p><i>Attributes are displayed in italics.</i></p>
Description	<p>Describes the purpose of the element or attribute including the units (if applicable). The absence of a unit designation for string data types implies a string literal and for numerical data types (integers, floats, etc...) the absence of a unit designation implies an absolute number.</p> <p>Elements are displayed in normal font.</p> <p><i>Attributes are displayed in italics.</i></p>
Data Type	<p>Defines the data type of the element or attribute.</p> <p>Elements are displayed in normal font.</p> <p><i>Attributes are displayed in italics.</i></p>
Cardinality	<p>Elements are displayed in normal font and this column defines the number of occurrences of the element in the form:</p> <p>[minOccurs ..] maxOccurs</p> <p><i>Attributes are displayed in italics and this column describes the use of the attribute where, "optional" means the attribute may or may not be present and "required" means the presence of the attribute is mandatory.</i></p>

## 3.6.3 Primitive Data Types

Table 3-19 describes the primitive data types defined in the Sentinel-1 namespace. For data types which express floating point or integer numbers, these are expressed as ASCII strings in XML files with enough digits to express the full precision of the data type.

Note that ASAR options are only valid for ASAR offline test products and will not be available operationally.

**Table 3-19 Primitive Data Types for Sentinel-1 Product Format**

Type Name	Description	Range
chirpSourceType	Enumeration of the available chirp schemes.	Extracted, Nominal
pgSourceType	Enumeration of the available PG schemes.	Extracted, Model
rrfSpectrumType	The type of range matched filter to use during processing. "Unextended": range reference function is unextended in frequency domain; "Extended Flat": range reference function is extended and flat in frequency domain; and, "Extended Tapered": range reference function is extended and tapered in frequency domain.	Unextended, Extended Flat, Extended Tapered
dcMethodType	Enumeration of Doppler centroid calculation/estimation methods.	Data Analysis, Orbit and Attitude, Pre-defined
dcInputDataType	Enumeration of input data types for Doppler centroid estimation.	Raw, Range Compressed
timeType	Time with respect to the specified reference time system. All times are with respect to UTC and can provide up to 1 microsecond resolution.	
imageNumberType	Image number type. For WV products the image number is used to distinguish between vignettes. For SM, IW and EW modes the image number is still used but refers instead to each swath and polarisation combination (known as the "channel") of the data. This value ranges from 001 to 999.	00[1-9][0[1-9][0-9]][1-9][0-9][0-9]
swathType	Enumeration of all valid swath identifiers for the Sentinel-1 SAR instrument. The S1-S6 swaths apply to SM products, the IW and IW1-3 swaths apply to IW products (IW is used for detected IW products where the 3 swaths are merged into one image), the EW and EW1-5 swaths apply to EW products (EW is used for detected EW products where the 5 swaths are merged into one image), and the WV1-2 swaths apply to WV products. The EN, N1-N6 swaths apply to the Sentinel-1 notch modes used for instrument calibration. The RF swath applies to the Sentinel-1 RFC mode which is not processed by the IPF. The IS1-IS7 swaths apply to ASAR IM and WV products.	S1, S2, S3, S4, S5, S6, IW, IW1, IW2, IW3, EW, EW1, EW2, EW3, EW4, EW5, WV, WV1, WV2, EN, N1, N2, N3, N4, N5, N6, RF, IS1, IS2, IS3, IS4, IS5, IS6, IS7
swathNumberType	Swath number from SPPDU.	0 .. 127
weightingWindowType	Enumeration of weighting window names.	Hamming, None



Type Name	Description	Range
polarisationType	Enumeration of valid polarisations for the Sentinel-1 SAR instrument.	HH, HV, VH, VV
sensorModeType	Enumeration of the SAR instrument imaging modes.	S1, S2, S3, S4, S5, S6, IW, EW, WV, EN, N1, N2, N3, N4, N5, N6, RF, IM
passDirectionType	Enumeration of the orbit pass direction values.	Ascending, Descending
projectionType	Enumeration of the image projection.	Slant Range, Ground Range
pixelValueType	Enumeration of output pixel value interpretation types.	Complex, Detected
outputPixelsType	Enumeration of output pixel data types.	32 bit Float, 16 bit Signed Integer, 16 bit Unsigned Integer, 8 bit Unsigned Integer
dataFormatModeType	Enumeration of compression method names. This enumeration is a consolidated list from the Sentinel-1 SPPDU document and the ENVISAT Product Specification.	FDBAQ, BAQ 3 Bit, BAQ 4 Bit, BAQ 5 Bit, Decimation, Bypass, Full 8 Bit, SM, FBAQ 2 Bit, FBAQ 3 Bit, FBAQ 4 Bit, None
productCompositionType	Enumeration of product composition indicators. The valid values are: "Individual", to indicate a full non-sliced product; "Slice", to indicate that this is a single slice of a larger product; and "Assembled", to indicate that this is a product that has been created by combining multiple slices.	Individual, Slice, Assembled
aocsOpModeType	Enumeration of the available AOCS operational mode from the pointing status in the downlink.	No Mode, Normal Pointing Mode, Orbit Control Mode
missionIdType	Sentinel-1 mission identifier. The S1A option is used for products produced for the Sentinel-1A instrument and the S1B is used for products produced for the Sentinel-1B instrument. The ASA option is used for products produced from the ENVISAT ASAR instrument.	S1A, S1B, ASA
productType	Output product type.	SLC, GRD, OCN
absOrbitNumberType	Absolute orbit number.	1-999999
missionDataTakeIdType	Mission data take identifier.	1-999999
referenceFrameType	Enumeration of coordinate system reference frames supported by the EO CFI.	Undefined, Galactic, BM1950, BM2000, HM2000, GM2000, Mean Of Date, True Of Date, Pseudo Earth Fixed, Earth Fixed, Topocentric, Satellite Orbital, Satellite Nominal, Satellite Attitude, Instrument Attitude
topsFilterOriginType	Enumeration of valid origins for defining the TOPS ramping/de-ramping filter.	All Lines, Only Echo Lines
orbitAttitudeSourceType	Enumeration for the sources of orbit and attitude data.	Downlink, Auxiliary
burstIdType	Burst identification number relative to the current mission cycle	1 .. 999999
bool	Boolean (true or false).	true, false
string	Character string.	1 .. 512 UTF-8 characters.
unsignedLong	64 bit unsigned integer.	0 .. 18446744073709551616
unsignedInt	32 bit unsigned integer.	0 .. 4294967295
unsignedShort	16 bit unsigned integer.	0 .. 65535
unsignedByte	8 bit unsigned integer.	0 .. 255

Type Name	Description	Range
int64	64 bit signed integer.	-9223372036854775808 .. 9223372036854775807
uint64	64 bit unsigned integer.	0 .. 18446744073709551616
int32	32 bit signed integer.	-2147483648 .. 2147483647
uint32	32 bit unsigned integer.	0 .. 4294967295
int16	16 bit signed integer.	-32768 .. 32767
uint16	16 bit unsigned integer.	0 .. 65535
byte	8 bit signed byte.	-128 .. 127
ubyte	8 bit unsigned byte.	0 .. 255
float	32 bit (7 decimal digits) single precision floating point number with an optional "units" attribute.	Machine dependent
double	64 bit (16 decimal digits) double precision floating point number with an optional "units" attribute.	Machine dependent
complex	64 bit complex number consisting of a 32 bit single precision floating point real part and a 32 bit single precision floating point imaginary part.	Machine dependent
floatArray	String containing an array of float values separated by spaces. The mandatory count attribute defines the number of elements in the array.	0 .. 25100 float values
doubleArray	String containing an array of double values separated by spaces. The mandatory count attribute defines the number of elements in the array.	0 .. 25100 double values
complexArray	String containing an array of complex values separated by spaces. The mandatory count attribute defines the number of complex elements in the array.	0 .. 25100 complex values
intArray	String containing an array of int values separated by spaces. The mandatory count attribute defines the number of elements in the array.	0 .. 25100 integer values
floatCoefficientArray	String containing an array of float values separated by spaces. The mandatory count attribute defines the number of elements in the array.	0 .. 22 float values
doubleCoefficientArray	String containing an array of double values separated by spaces. The mandatory count attribute defines the number of elements in the array.	0 .. 22 double values
adsHeaderType	Common header for all Annotation Data Sets. This record contains the information necessary to identify Annotation Data Sets and link them to the appropriate Measurement Data Set. See Table 3-20 below.	Not Applicable

**Table 3-20 Data Type - adsHeaderType**

Name	Description	Data Type	Cardinality
missionId	Mission identifier for this data set.	missionIdType	1
productType	Product type for this data set.	productType	1
polarisation	Polarisation for this data set.	polarisationType	1
mode	Sensor mode for this data set.	sensorModeType	1
swath	Swath identifier for this data set. This element identifies the swath that applies to all data contained within this data set. The swath identifier "EW" is used for products in which the 5 EW swaths have been merged. Likewise, "IW" is used for products in which the 3 IW swaths have been merged.	swathType	1
startTime	Zero Doppler start time of the output image [UTC].	timeType	1
stopTime	Zero Doppler stop time of the output image [UTC].	timeType	1
absoluteOrbitNumber	Absolute orbit number at data set start time.	absOrbitNumberType	1
missionDataTakeId	Mission data take identifier.	missionDataTakeIdType	1
imageNumber	Image number. For WV products the image number is used to distinguish between vignettes. For SM, IW and EW modes the image number is still used but refers instead to each swath and polarisation combination (known as the 'channel') of the data.	imageNumberType	1



## 4 LEVEL 1 PRODUCT SPECIFICATION



This section defines the composition of all Level 1 products; that is, the collection of data sets included in each Sentinel-1 Level-1 product type. It defines how the measurement, annotation and representation data sets presented in Section 6 are put together to form a complete Sentinel-1 Level 1 product.

### 4.1 Level 1 SLC Products

This section defines the composition of Sentinel-1 Level-1 SLC products. The collection of data sets that comprise Level-1 SLC products is presented in Table 4-1. Table 4-2 lists the data set records from the Level 1 product annotation data set that are included in the Level 1 SLC products.

**Table 4-1 Sentinel-1 Level 1 SLC Product Composition**

File/Folder Name	SM/EN/AN	IW	EW	WV
 MMM_BB_TTTR_LFPP_YYYYMMDDTHHMMSS_YYYYMMDDTHHMMSS_OOOOOO_DDDDDD_CCCC.SAFE				
 manifest.safe	1	1	1	1
 annotation/	1	1	1	1
 mmm-sss-ttt-pp-yyyymmddthhmmss-yyyymmddthhmmss-oooooo-dddddd-nnn.xml	1 per pol.	1 per pol. per swath <sup>1</sup>	1 per pol. per swath <sup>1</sup>	1 per vignette
 calibration/	1	1	1	1
 calibration-mmm-sss-ttt-pp-yyyymmddthhmmss-yyyymmddthhmmss-oooooo-dddddd-nnn.xml	1 per pol.	1 per pol. per swath <sup>1</sup>	1 per pol. per swath <sup>1</sup>	1 per vignette
 noise-mmm-sss-ttt-pp-yyyymmddthhmmss--yyyymmddthhmmss-oooooo-dddddd-nnn.xml	1 per pol.	1 per pol. per swath <sup>1</sup>	1 per pol. per swath <sup>1</sup>	1 per vignette
 rfi/	1	1	1	1
 rfi-mmm-sss-ttt-pp-yyyymmddthhmmss--yyyymmddthhmmss-oooooo-dddddd-nnn.xml	1 per pol.	1 per pol. per swath <sup>1</sup>	1 per pol. per swath <sup>1</sup>	1 per vignette
 measurement/ <sup>1</sup>	1	1	1	1
 mmm-sss-ttt-pp-yyyymmddthhmmss-yyyymmddthhmmss-oooooo-dddddd-nnn.tiff <sup>1</sup>	1 per pol.	1 per pol. per swath <sup>1</sup>	1 per pol. per swath <sup>1</sup>	1 per vignette
 preview/	1	1	1	1
 map-overlay.kml	1	1	1	1
 product-preview.html	1	1	1	1
 quick-look.png	0 or 1	0 or 1	0 or 1	0
 icons/	1	1	1	1
 logo.png	As required	As required	As required	As required
 support/	1	1	1	1
 s1-level-1-calibration.xsd	1	1	1	1
 s1-level-1-measurement.xsd	1 <sup>1</sup>	1 <sup>1</sup>	1 <sup>1</sup>	1 <sup>1</sup>
 s1-level-1-noise.xsd	1	1	1	1
 s1-level-1-rfi.xsd	1	1	1	1
 s1-level-1-product.xsd	1	1	1	1
 s1-level-1-quicklook.xsd	1	1	1	0

File/Folder Name	SM/EN/AN	IW	EW	WV
 s1-map-overlay.xsd	1	1	1	1
 s1-object-types.xsd	1	1	1	1
 s1-product-preview.xsd	1	1	1	1

Notes:

- 1 – The start and stop times for TOPS SLC products are different for each swath.
- 2 – Excluded from Annotation Products.

**Table 4-2 Level 1 Product Annotation DSR Applicable to Level 1 SLC Products**

Data Set Record Name	SM/EN/AN	IW	EW	WV
Quality Information	✓	✓	✓	✓
General Annotation	✓	✓	✓	✓
Image Annotation	✓	✓	✓	✓
Doppler Centroid	✓	✓	✓	✓
Antenna Pattern	✓	✓	✓	✓
Swath Timing		✓	✓	
Geolocation Grid	✓	✓	✓	✓
Coordinate Conversion				
Swath Merging				

## 4.2 Level 1 GRD Products

This section defines the composition of Sentinel-1 Level-1 GRD products. The collection of data sets that comprise Level-1 GRD products is presented in Table 4-3. Table 4-4 lists the data set records from the Level 1 product annotation data set that are included in the Level 1 GRD products.

**Table 4-3 Sentinel-1 Level 1 GRD Product Composition**

File/Folder Name	SM/EN/AN	IW	EW	WV
 MMM_BB_TTTR_LFPP_YYYYMMDDTHHMMSS_YYYYMMDDTHHMMSS_OOOOOO_DDDDDD_CCCC.SAFE				
 manifest.safe	1	1	1	1
 annotation/	1	1	1	1
 mmm-sss-ttt-pp-yyyymmddthhmmss-yyyymmddthhmmss-oooooo-dddddd-nnn.xml	1 per pol.	1 per pol.	1 per pol.	1 per vignette
 calibration/	1	1	1	1
 calibration-mmm-sss-ttt-pp-yyyymmddthhmmss-yyyymmddthhmmss-oooooo-dddddd-nnn.xml	1 per pol.	1 per pol.	1 per pol.	1 per vignette
 noise-mmm-sss-ttt-pp-yyyymmddthhmmss-yyyymmddthhmmss-oooooo-dddddd-nnn.xml	1 per pol.	1 per pol.	1 per pol.	1 per vignette
 rfi/	1	1	1	1
 rfi-mmm-sss-ttt-pp-yyyymmddthhmmss-yyyymmddthhmmss-oooooo-dddddd-nnn.xml	1 per pol.	1 per pol.	1 per pol.	1 per vignette
 measurement/ <sup>1</sup>	1	1	1	1
 mmm-sss-ttt-pp-yyyymmddthhmmss-yyyymmddthhmmss-oooooo-dddddd-nnn.tiff <sup>1</sup>	1 per pol.	1 per pol.	1 per pol.	1 per vignette
 preview/	1	1	1	1
 map-overlay.kml	1	1	1	1
 product-preview.html	1	1	1	1
 quick-look.png	0 or 1	0 or 1	0 or 1	0
 icons/	1	1	1	1
 logo.png	As required	As required	As required	As required
 support/				
 s1-level-1-calibration.xsd	1	1	1	1
 s1-level-1-measurement.xsd	1 <sup>1</sup>	1 <sup>1</sup>	1 <sup>1</sup>	1 <sup>1</sup>
 s1-level-1-noise.xsd	1	1	1	1
 s1-level-1-rfi.xsd	1	1	1	1
 s1-level-1-product.xsd	1	1	1	1
 s1-level-1-quicklook.xsd	1	1	1	0



# Sentinel-1

Ref: S1-RS-MDA-52-7441  
 MPC Nom: DI-MPC-PB  
 MPC Ref: MPC-0240  
 Issue/Revision: 3/12  
 Date: 19/09/2022

s1-map-overlay.xsd	1	1	1	1
s1-object-types.xsd	1	1	1	1
s1-product-preview.xsd	1	1	1	1

Notes:

1 – Excluded from Annotation Products.

**Table 4-4 Level 1 Product Annotation DSR Applicable to Level 1 GRD Products**

Data Set Record Name	SM/EN/AN	IW	EW	WV
Quality Information	✓	✓	✓	✓
General Annotation	✓	✓	✓	✓
Image Annotation	✓	✓	✓	✓
Doppler Centroid	✓	✓	✓	✓
Antenna Pattern	✓	✓	✓	✓
Swath Timing				
Geolocation Grid	✓	✓	✓	✓
Coordinate Conversion	✓	✓	✓	✓
Swath Merging		✓	✓	



















## 5 LEVEL 2 PRODUCT SPECIFICATION

This section defines the composition of all Level 2 products; that is, the collection of data sets included in each Sentinel-1 Level 2 product. It defines how the measurement, annotation and representation data sets presented in Section 6 are put together to form a complete Sentinel-1 Level 2 product.

### 5.1 Level 2 OCN Products

This section defines the composition of Sentinel-1 Level 2 OCN products. The collection of data sets that comprise Level 2 OCN products is presented in Table 5-1.



**Table 5-1 Sentinel-1 Level 2 OCN Product Composition**

File/Folder Name	SM	IW	EW	WV
 MMM_BB_TTTR_LFPP_YYYYMMDDTHHMMSS_YYYYMMDDTHHMMSS_OOOOOO_DDDDDD_CCCC.SAFE				
 manifest.safe	1	1	1	1
 measurement/	1	1	1	1
 mmm-sss-ttt-pp-yyyymmddthhmmss-yyyymmddthhmmss-ooooo- dddddd-nnn.nc	1	1	1	1 per vignette
 preview/	1	1	1	1
 map-overlay.kml	1	1	1	1
 product-preview.html	1	1	1	1
 owi-colorbar.png	0 or 1	0 or 1	0 or 1	0
 rv1-colorbar.png	0 or 1	0 or 1	0 or 1	0
 quick-look-l2-owi.png	0 or 1	0 or 1	0 or 1	0
 quick-look-l2-rv1.png	0 or 1	0 or 1	0 or 1	0
 icons/	1	1	1	1
 logo.png	As required	As required	As required	As required
 support/	1	1	1	1
 s1-level-2-measurement.xsd	1	1	1	1
 s1-level-2-png.xsd				



# Sentinel-1

Ref: S1-RS-MDA-52-7441  
MPC Nom: DI-MPC-PB  
MPC Ref: MPC-0240  
Issue/Revision: 3/12  
Date: 19/09/2022

File/Folder Name	SM	IW	EW	WV
 s1-map-overlay.xsd	1	1	1	1
 s1-object-types.xsd	1	1	1	1
 s1-product-preview.xsd	1	1	1	1

## 6 PRODUCT DATA SETS

The sub-sections within this section describe in detail all of the data sets that are or can be included with any of the Sentinel-1 products.

### 6.1 Manifest File

The objective of this section is to define the mandatory components of the manifest file that are present in all Sentinel-1 products. A graphical representation of the top level of the manifest file is shown in Figure 6-1, and the XML structure is described in

Table 6-1. These structures are further decomposed in sections 6.1.1 through 6.1.3.

Within the tables below text in normal font is used to describe XML elements and text in *italicised* font is used to describe XML attributes.

The data types used in the manifest structure are part of the SAFE specification and Sentinel-1 specialisation of SAFE XFDU, whereas the types used elsewhere in this document are defined specifically for Sentinel-1 product files. These types are independent of each other because they are defined in different schemas and different XML namespaces; however, in some cases, the data type names used by SAFE, the Sentinel-1 SAFE specialisation and those defined for Sentinel-1 may overlap. A table of manifest-specific primitive data types used for Sentinel-1 products is presented in Table 6-2 and the structure of the manifest file is presented in Table 6-7.

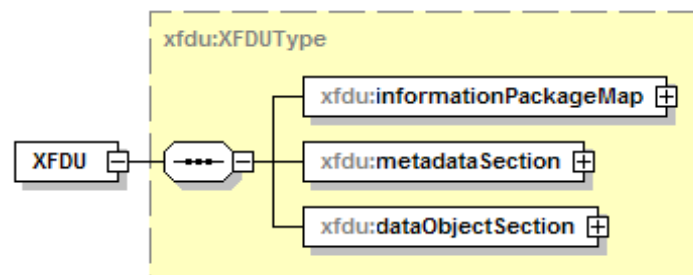

**Figure 6-1 Sentinel-1 Manifest File Structure**



# Sentinel-1

Ref: S1-RS-MDA-52-7441  
 MPC Nom: DI-MPC-PB  
 MPC Ref: MPC-0240  
 Issue/Revision: 3/12  
 Date: 19/09/2022

**Table 6-1 Element - XFDU**

Name	Description	Data Type	Cardinality
<i>Version</i>	<i>The version attribute describes the location within the SAFE schema directory structure where the validating XFDU schema file for this manifest file resides.</i>	<i>string</i>	<i>required</i>
informationPackageMap	The information package map contains a high-level textual description of the product and references to all of the MDS and ADS contained within the product.	informationPackageMap Type	1
metadataSection	The metadata section contains a minimal set of wrapped product metadata that can be used for product identification and cataloguing, and it also contains references to each of the physical annotation data sets contained within the product.	metadataSectionType	1
dataObjectSection	The dataObjectSection contains the dataObjects that represent the measurement and annotation data sets included in the product. Each dataObject within the dataObjectSection represents a physical data file on the file system.	dataObjectSectionType	1

**Table 6-2 Primitive Data Types for Sentinel-1 Manifest Format**

Type Name	Description	Range	Origin
signType	Enumeration for sign of leap second.	+, -	Matches S1 L0 Spec definition
modeType	Instrument mode used to acquire the data segment.	SM, IW, EW, WV, EN, AN, IM	Adapted from S1 L0 Spec, ASAR option added for L1
swathType	Enumeration of all valid swath identifiers for the Sentinel-1 SAR instrument. The S1-S6 swaths apply to SM products, the IW and IW1-3 swaths apply to IW products (IW is used for detected IW products where the 3 swaths are merged into one image), the EW and EW1-5 swaths apply to EW products (EW is used for detected EW products where the 5 swaths are merged into one image), and the WV1-2 swaths apply to WV products. The EN and N1-N6 beams apply to the notch acquisition modes. The IS1-IS7 swaths apply to ASAR IM and WV products.	S1, S2, S3, S4, S5, S6, IW, IW1, IW2, IW3, EW, EW1, EW2, EW3, EW4, EW5, WV, WV1, WV2, EN, N1, N2, N3, N4, N5, N6, IS1, IS2, IS3, IS4, IS5, IS6, IS7	Added for S1 L1/L2 products

Type Name	Description	Range	Origin
passType	Direction of the orbit (ascending, descending) for the oldest ISP in the product.	ASCENDING, DESCENDING	Similar to S1 L0 Spec definition
productTypeType	Product type of product.	SLC, GRD, OCN	Added for S1 L1/L2 products
transmitterReceiverPolarisationType	Polarization of the data segment contained in a Data Object.	HH,VV,HV,VH	Matches S1 L0 Spec definition
productTimelinessCategoryType	Describes the required timeliness of the processing.	NRT-10m, NRT-1h, NRT-3h, Fast-24h, Off-line, Reprocessing	Added for S1 L1/L2 products
productClassType	Enumeration of the product classes.	A, S	Matches S1 L0 Spec definition
productClassDescriptionType	Textual descriptions of product classes.	SAR Standard L1 Product, SAR Annotation L1 Product, SAR Standard L2 Product, SAR Annotation L2 Product	Added for S1 L1/L2 products
productCompositionType	Enumeration of the product composition types.	Individual, Slice, Assembled	Added for S1 L1/L2 products

## 6.1.1 Information Package Map

The manifest file contains exactly one information package map with one content unit as a child element. Beneath the first content unit is a list of content units that define the metadata and data objects within the product; that is, the data sets that make up the product.

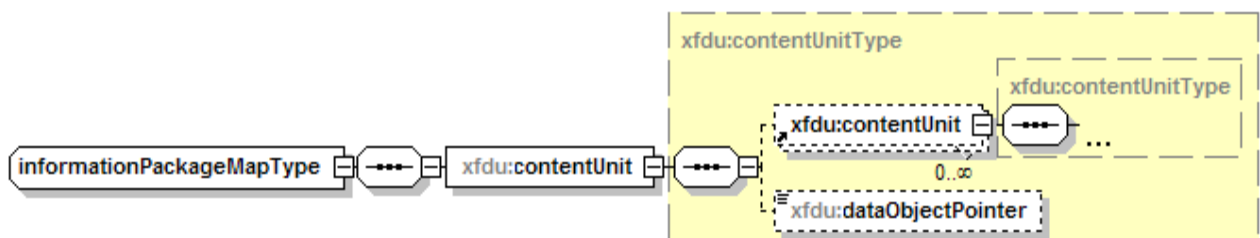

Figure 6-2 Information Package Map Structure

Table 6-3 Data Type - informationPackageMapType

Name	Description	Data Type	Cardinality
contentUnit	The informationPackageMap contains exactly 1 contentUnit and this contentUnit catalogues the physical data components included in the product.	contentUnitType	1

**Table 6-4 Data Type - contentUnitType**

Name	Description	Data Type	Cardinality
<i>ID</i>	<i>Unique identifier for this contentUnit.</i>	<i>ID</i>	<i>optional</i>
<i>unitType</i>	<i>Describes the type of data referenced by this content unit.</i>	<i>string</i>	<i>required</i>
<i>textInfo</i>	<p><i>A brief textual description of the information or data referenced by this content unit. This field is free text.</i></p> <p><i>Examples of content :</i></p> <p><i>textInfo="Sentinel-1 Level-2 OCN Annotation Product"</i></p> <p><i>textInfo="SENTINEL-1B L2 Auxiliary Processor Parameters"</i></p> <p><i>textInfo="Sentinel-1 IW Level-1 GRD Product"</i></p>	<i>string</i>	<i>optional</i>
<i>repID</i>	<i>Identifier of the representation data set(s) applicable to this content unit. This can be a single item or a list with each item separated by a space.</i>	<i>IDREFS</i>	<i>optional</i>
<i>dmdID</i>	<i>Identifier of the metadata or annotation data set(s) applicable to this content unit. This can be a single item or a list with each item separated by a space.</i>	<i>IDREFS</i>	<i>optional</i>
<i>pdiID</i>	<i>Identifier of the preservation description information applicable to this content unit. For Sentinel-1 products this attribute shall always point to the "processing" wrapped metadata object.</i>	<i>IDREFS</i>	<i>optional</i>
<i>contentUnit</i>	Content unit elements may include other content units or may be internal pointers to elements in the data object section. Content units are used to associate data objects with one or more metadata objects and present a view of these data/metadata associations.	contentUnitType	0 .. ∞
<i>dataObjectPointer</i>	Through the use of its dataObjectID attribute, this element points to the data object in the dataObjectSection that this content unit describes.	dataObjectPointerType	0 .. 1

## 6.1.2 Metadata Section

The manifest file contains exactly one metadata section. The metadata section contains a list of metadata objects that contain either wrapped metadata (information included directly in the manifest file), a data object pointer that refers to a physical annotation data set file on disk, or a metadata reference that points to a representation data set schema file on disk.

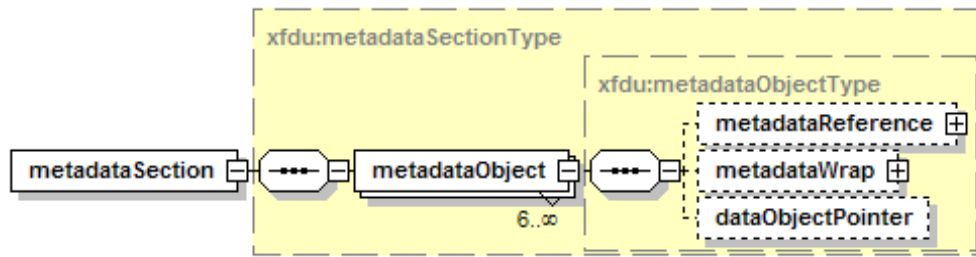

**Figure 6-3 Metadata Section Structure and Content**

**Table 6-5 Data Type - metadataSectionType**

Name	Description	Data Type	Cardinality
metadataObject	<p>Metadata objects can take one of three forms: the first is "wrapped metadata" in which valid XML data is embedded directly in the manifest file itself using an metadataWrap element; the second is a reference to an annotation data set in the dataObjectSection through a dataObjectPointer element; and, the third is a physical reference to a representation data set on the filesystem through the use of a metadataReference element.</p> <p>For Sentinel-1 products a minimum of 6 metadataObjects shall be present dedicated to: processing, acquisitionPeriod, platform, measurementOrbitReference, measurementFrameSet and generalProductInformation metadataWrap objects.</p>	metadataObjectType	6 .. ∞

**Table 6-6 Data Type - metadataObjectType**

Name	Description	Data Type	Cardinality
<i>ID</i>	<i>Unique identifier of this meta data object.</i>	<i>ID</i>	<i>required</i>
<i>Category</i>	<i>Defines the category of this meta data. The category is used to specify the nature of the metadata, whether it is preservation information (PDI), description information (DMD) or representation information (REP)</i>	<i>string</i>	<i>required</i>
<i>Classification</i>	<i>A textual description of the classification of this meta data. The classification is linked to the category and provides a more verbose description of the nature of the metadata, whether it is preservation information (PROVENANCE), description information (DESCRIPTION) or representation information (REPRESENTATION)</i>	<i>string</i>	<i>required</i>
dataObjectPointer	The dataObjectPointer element is used when the metadata object is an annotation data set. The dataObjectPointer element is used to point to the applicable annotation data set in the dataObject section through its dataObjectID attribute.	dataObjectPointerType	0 .. 1



Name	Description	Data Type	Cardinality
metadataWrap	The metadataWrap element is used to embed XML metadata directly in the manifest file itself. This element is used to express information that can be used for product identification and cataloguing.	metadataWrapType	0 .. 1
metadataReference	The metadataReference element is used when the metadata object is a representation data set. The metadataReference element is used to specify the physical file location of the applicable representation data set.	metadataReferenceType	0 .. 1

The mandatory wrapped metadata elements included in all Sentinel-1 products are described in Table 6-7.



# Sentinel-1

Ref: S1-RS-MDA-52-7441  
 MPC Nom: DI-MPC-PB  
 MPC Ref: MPC-0240  
 Issue/Revision: 3/12  
 Date: 19/09/2022

**Table 6-7 Mandatory Wrapped Metadata Elements for Sentinel-1 Products**

Name				Description	Data Type	Cardinality
safe:processing				Metadata describing the processing steps performed on the auxiliary data.	processingType	1
	<i>Name</i>			<i>Name of the processing step used to create the product.</i>	<i>string</i>	<i>required</i>
	<i>Start</i>			<i>Processing start time.</i>	<i>dateTime</i>	<i>required</i>
	<i>Stop</i>			<i>Processing stop time.</i>	<i>dateTime</i>	<i>required</i>
safe:facility				Identifies an organisation authority of the processing step.	facilityType	1
		<i>country</i>		<i>Name of the country where the facility is located. This element is configurable within the IPF.</i>	<i>string</i>	<i>required</i>
		<i>name</i>		<i>Name of the facility where the processing step was performed. This element is configurable within the IPF.</i>	<i>string</i>	<i>required</i>
		<i>organisation</i>		<i>Name of the organisation responsible for the facility. This element is configurable within the IPF.</i>	<i>string</i>	<i>required</i>
		<i>site</i>		<i>Geographical location of the facility. This element is configurable within the IPF.</i>	<i>string</i>	<i>required</i>
		safe:software		Reference to the software used for the processing step.	softwareType	0 .. ∞
			<i>name</i>	<i>Name of the software.</i>	<i>string</i>	<i>required</i>
			<i>version</i>	<i>Software version identification.</i>	<i>string</i>	<i>optional</i>
safe:resource				Reference to resources involved in the processing. This includes references to orbit and attitude files used to process the product. See Section 3.3.5 for a description of the resources included with each product.	resourceType	0 .. ∞
		<i>name</i>		<i>Name of the resource.</i>	<i>string</i>	<i>required</i>
		<i>role</i>		<i>Role the resource played in processing.</i>	<i>string</i>	<i>required</i>
		<i>href</i>		<i>URL of the resource.</i>	<i>anyURI</i>	<i>optional</i>



# Sentinel-1

Ref: S1-RS-MDA-52-7441  
 MPC Nom: DI-MPC-PB  
 MPC Ref: MPC-0240  
 Issue/Revision: 3/12  
 Date: 19/09/2022

Name				Description	Data Type	Cardinality
		processing		Metadata describing the processing steps performed on the auxiliary data by the resource. A resource can have its own processing metadata entry that may contain resources with their own processing entries. Each additional resource and processing entry is nested within the previous entry. For the IPF, the entries can be “SLC Processing”, “Post Processing” or “L2 Processing”.	processingType	0 .. ∞
			xmlns	For all sub-processing elements, the xmlns attribute shall be included and set to the safe namespace URI <a href="http://www.esa.int/safe/sentinel-1.0">http://www.esa.int/safe/sentinel-1.0</a>	anyURI	required
safe:acquisitionPeriod				Time extent of the Sentinel-1 L1 product.	acquisitionPeriodType	1
	safe:startTime			Sensing start time of the input data used to produce the output image.	dateTime	1
	safe:stopTime			Sensing stop time of the input data used to produce the output image.	dateTime	1
	safe:extension				extensionType	1
		s1:timeANX			s1:timeANXType	1
			s1:startTimeANX	Sensing start time of the input data relative to the ascending node crossing. This is a count of the time elapsed since the orbit ascending node crossing [ms].	double	1
			s1: stopTimeANX	Sensing stop time of the input data relative to the ascending node crossing. This is a count of the time elapsed since the orbit ascending node crossing [ms].	double	1
safe:platform				Metadata describing the mission platform to which acquired the data.	platformType	1
	safe:nssdcIdentifier			Univocally identifies the mission according to standard defined by the World Data Center for Satellite Information (WDC-SI), available at <a href="http://nssdc.gsfc.nasa.gov/nmc/scquery.html">http://nssdc.gsfc.nasa.gov/nmc/scquery.html</a>	string	1
	safe:familyName			The full mission name. E.g. “SENTINEL-1”	string	1
	safe:number			The alphanumeric identifier of the platform within the mission.	string	1
	safe:instrument			Information related to the instrument on the platform to which acquired the data.	instrumentType	1
		safe:familyName		Instrument name.	string	1



# Sentinel-1

Ref: S1-RS-MDA-52-7441  
 MPC Nom: DI-MPC-PB  
 MPC Ref: MPC-0240  
 Issue/Revision: 3/12  
 Date: 19/09/2022

Name				Description	Data Type	Cardinality
			<i>abbreviation</i>	<i>Abbreviated instrument name.</i>	<i>string</i>	<i>required</i>
	safe:extension				extensionType	1
		s1sar:instrumentMode			s1sar:instrumentModeType	1
			s1sar:mode	Instrument mode.	s1sar:modeType	1
			s1sar:swath	List of the swaths contained within a product. Most products will contain only one swath, except for TOPS SLC products which include 3 or 5 swaths.	s1sar:swathType	1..5
	safe:extension			This element is only present if it was present in the input L0 product, and if so the leapSecondInformation information in the L0 product is copied into the L1/L2 product.	extensionType	0..1
		s1:leapSecondInformation		Information on the leap second applied to the product UTC timing. This element is only present if it was present in the input L0 product, and if so the leapSecondInformation information in the L0 product is copied into the L1/L2 product.	s1:leapSecondInformationType	0..1
			s1:utcTimeOfOccurrence	UTC time of occurrence of leap second (if leap second occurred in the product time window); it represents the time after the leap second occurrence (i.e. midnight of day after the leap second)	dateTime	1
			s1:sign	Sign of leap second (+ or -).	s1:signType	1
safe:orbitReference				Contains information describing the orbit or the orbit range of the image data.	orbitReferenceType	1
	safe:orbitNumber			Absolute orbit number.	orbitNumberType	1
		start		<i>Absolute orbit number of the oldest line within the image data.</i>	<i>unsignedInt</i>	<i>required</i>
		stop		<i>Absolute orbit number of the most recent line within the image data.</i>	<i>unsignedInt</i>	<i>required</i>
	safe:relativeOrbitNumber			Relative orbit number.	relativeOrbitNumberType	1
		start		<i>Relative orbit number of the oldest line within the image data.</i>	<i>unsignedInt</i>	<i>required</i>
		stop		<i>Relative orbit number of the most recent line within the image data.</i>	<i>unsignedInt</i>	<i>required</i>



# Sentinel-1

Ref: S1-RS-MDA-52-7441  
 MPC Nom: DI-MPC-PB  
 MPC Ref: MPC-0240  
 Issue/Revision: 3/12  
 Date: 19/09/2022

Name				Description	Data Type	Cardinality
	safe:cycleNumber			Absolute sequence number of the mission cycle to which the oldest image data applies.	unsignedInt	1
	safe:phaseIdentifier			Id of the mission phase to which the oldest image data applies.	unsignedInt	1
	safe:extension				extensionType	1
		s1:orbitProperties			s1:orbitPropertiesType	
			s1: pass	Direction of the orbit (ascending, descending) for the oldest image data in the product (the start of the product).	s1:passType	1
			s1:ascendingNodeTime	UTC time of the ascending node of the orbit. This element is present for all products except ASAR L2 OCN products which are generated from an ASAR L1 input.	dateTime	0 .. 1
safe:frameSet				Geographical and time location of the instrument footprint, considered as a single frame. This element is present for all products except ASAR L2 OCN products which are generated from an ASAR L1 input.	frameSetType	0 .. 1
	safe:frame			The instrument footprint frame. There is one frame per product for SM, IW and EW modes, and one frame per vignette for WV mode products.	frameType	1 .. 200
		safe:number		Number of the WV vignette which this frame describes.	unsignedInt	0 .. 1
		safe:footprint		Coordinates of instrument footprint in GML notation (gml:coordinates type as defined in <a href="http://www.opengis.net/gml">http://www.opengis.net/gml</a> , namely string with 4 pairs of coordinates (lon,lat of near and far range at start and stop time of the image) separated by a space.	gml:LinearRingType	1
s1sar1:standAloneProductInformation				Metadata describing the product.	s1sar:standAloneProductInformationType	1
	s1sar1:instrumentConfigurationID			The instrument configuration ID (Radar database ID) for this data.	unsignedInt	1
	s1sar1:missionDataTakeID			Unique ID of the datatake within the mission.	unsignedInt	1
	s1sar1:transmitterReceiverPolarisation			Transmit/Receive polarisation for the data. There is one element for each Tx/Rx combination.	transmitterReceiverPolarisationType	1 .. 2
	s1sar1:productClass			Output product class "A" for Annotation or "S" for Standard.	productClassType	1



# Sentinel-1

Ref: S1-RS-MDA-52-7441  
 MPC Nom: DI-MPC-PB  
 MPC Ref: MPC-0240  
 Issue/Revision: 3/12  
 Date: 19/09/2022

Name				Description	Data Type	Cardinality
s1sar1:productClassDescription				Textual description of the output product class.	productClassDescriptionType	1
s1sar1:productComposition				The composition type of this product: "Individual", "Slice" or "Assembled".	productCompositionType	1
s1sar1:productType				The product type (correction level) of this product.	productTypeType	1
s1sar1:productTimelinessCategory				Describes the required timeliness of the processing. One of: <ul style="list-style-type: none"> <li>NRT-10m</li> <li>NRT-1h</li> <li>NRT-3h</li> <li>Fast-24h</li> <li>Off-line</li> <li>Reprocessing</li> </ul>	productTimelinessCategoryType	1
s1sar1:sliceProductFlag				True if this is a slice from a larger product or false if this is a complete product.	bool	1
s1sar1:segmentStartTime				Sensing start time of the segment to which this slice belongs. This field is only present if sliceProductFlag = true.	dateTime	0..1
s1sar1:sliceNumber				Absolute slice number of this slice starting at 1. This field is only present if sliceProductFlag = true.	unsignedInt	0..1
s1sar1:totalSlices				Total number of slices in the complete data take. This field is only present if sliceProductFlag = true.	unsignedInt	0..1

## 6.1.3 Data Object Section

The manifest file contains exactly one data object section. The data object section contains a list of data objects that contain references to the physical MDS and ADS data files on disk.

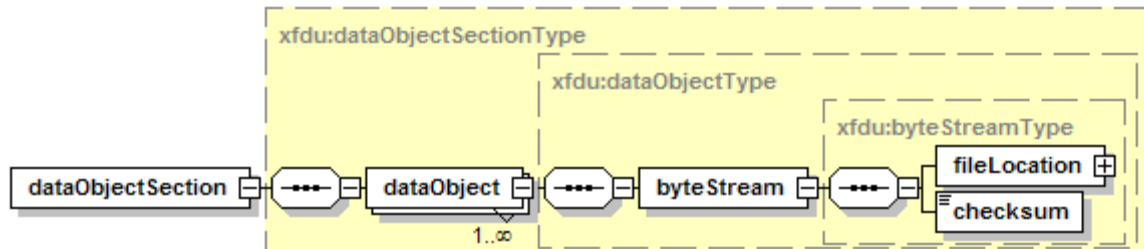

**Figure 6-4 Data Object Section Structure and Content**

**Table 6-8 Data Type - dataObjectSectionType**

Name	Description	Data Type	Cardinality
dataObject	Each data object refers to a physical file on the filesystem through the use of its byteStream element. The mandatory ID attribute is used by elements in the informationPackageMap and the metadataSection to refer to these physical data objects.	dataObjectType	1 .. ∞

**Table 6-9 Data Type - dataObjectType**

Name	Description	Data Type	Cardinality
ID	Unique identifier for this data object	ID	required
repID	Representation metadata identifier. This attribute describes the applicable RDS for this data object.	string	required
byteStream	The byte stream element points to the physical file that this data object represents. The byteStream element contains the location of the file and associated information like the format of the file, the size and the data integrity checksum.	byteStreamType	1

**Table 6-10 Data Type - byteStreamType**

Name	Description	Data Type	Cardinality
fileLocation	The fileLocation element contains the absolute path or URL to associated file through the use of its "href" attribute.	referenceType	1

Name	Description	Data Type	Cardinality
Checksum	Provides the integrity checksum for the file referred to by this byteStream element.	checksumInformationType	1

**Table 6-11 Data Type - referenceType**

Name	Description	Data Type	Cardinality
<i>locatorType</i>	<i>Defines the location type.</i>	<i>locatorTypeType</i>	<i>required</i>
<i>Href</i>	<i>Specifies the format of the file referred to by this byteStream element.</i>	<i>string</i>	<i>required</i>

**Table 6-12 Data Type - checksumInformationType**

Name	Description	Data Type	Cardinality
<i>checksumName</i>	<i>The name of the algorithm used to generate the checksum value.</i>	<i>checksumNameType</i>	<i>required</i>

## 6.2 Measurement Data Sets

This section describes the content and format of the measurement data sets used in Sentinel-1 products.

### 6.2.1 Level 1 Image

This section describes the image measurement data sets that can be included in a Sentinel-1 Level 1 product.

Image measurement data sets within Sentinel-1 L1 products are stored in GeoTIFF format [R-6] which is built upon the TIFF format [R-5]. Every GeoTIFF file is therefore a TIFF file. Some image files in Sentinel-1 products will be larger than 4 GB in size. The maximum size for a standard TIFF image is 4 GB, so in order to accommodate files larger than 4 GB is size, the BigTIFF format [R-7] is used. BigTIFF is also built upon the TIFF format, extending it to support files of an arbitrarily large size.

L1 SLC images are generated in 32-bit signed integer format with each pixel represented by two interleaved I&Q 16-bit signed integer samples in the order: IQIQIQ... L1 GRD images are generated in 16-bit unsigned integer format with each pixel representing a single 16-bit magnitude sample. In terms of TIFF output and metadata tags, this equates to:

For SLC images:  $BitsPerSample = 32$



*SamplesPerPixel* = 1

*SampleFormat* = 5 (complex integer, 'int16')

For GRD images: *BitsPerSample* = 16

*SamplesPerPixel* = 1

*SampleFormat* = 1 (unsigned integer, 'uint16')

Note that for all L1 images the IPF supports only pixel interleaving (band interleaving is not supported) and so *PlanarConfiguration* is always set to 1, meaning contiguous (or pixel interleaved).

The TIFF tags used to annotate Sentinel-1 image files are presented in Table 6-13 and the GeoTIFF tags and keys used to annotate Sentinel-1 image files are presented in Table 6-14.

**Table 6-13 Summary of TIFF Tags used in Sentinel-1 Products**

TIFF Tag Name	TIFF Tag Code	TIFF Tag Type	Value	Description
ImageWidth	256	LONG	Variable	Number of pixels per line.
ImageLength	257	LONG	Variable	Number of lines in image.
BitsPerSample	258	SHORT	32 or 16	Number of bits per sample. Set to 32 bits for SLC (16 bits I and 16 bits Q) and 16 bits for GRD.
Compression	259	SHORT	1	Compression scheme used. Always set to 1 (no compression).
PhotometricInterpretation	262	SHORT	1	Colour space of the image. Always set to 1 (minimum value is black).
ImageDescription	270	ASCII	Variable	A string that describes the image. Examples: "Sentinel-1A SM SLC L1" and "Sentinel-1A IW GRD MR L1".
StripOffsets	273	Array of LONG	Variable	Array of byte offsets for each strip within the image. For S1, each "strip" represents a range line, and the offset to the start of the image is the first value in the StripOffsets array.
Orientation	274	SHORT	1	The orientation of the image with respect to rows and columns. Always set to 1 (TOPLEFT) to indicate that the first sample is the upper left corner.
SamplesPerPixel	277	SHORT	1	Number of samples per pixel. Always set to 1.
RowsPerStrip	278	LONG	Variable	Number of rows per strip. Always set to 1.
StripByteCounts	279	Array of LONG	Variable	Array of the number of bytes in each strip. For S1, the number of bytes in each "strip" will be the same, as all image lines contain the same number and type of samples.

TIFF Tag Name	TIFF Tag Code	TIFF Tag Type	Value	Description
PlanarConfiguration	284	SHORT	1	Configuration in which the components (samples) of each pixel are stored. Always set to 1 (contiguous).
Software	305	ASCII	Variable	Software name and version that created the image.
DateTime	306	ASCII	Variable	Date and time of image creation in the format: YYYY:MM:DD HH:MM:SS
SampleFormat	339	SHORT	5 or 1	Interpretation of pixel format. Set to 5 (complex signed integer, 'int16') for SLC products, set to 1 (unsigned integer, 'uint16') for all others.

**Table 6-14 Summary of GeoTIFF Tags/Keys Used in Sentinel-1 Products**

GeoTIFF Tag/Key Name	GeoTIFF Tag/Key Code	Type	Value	Description
ModelTiePointTag	33922	Array of DOUBLE	N * (pixel,line,,0, lat, lng,0)	Maps image pixels to geographic coordinates, where N is the number of tie points in the scene.
GeoKeyDirectoryTag	34735	Array of SHORT	Variable	Contains the value of all GeoTIFF keys of type SHORT and the location of the values for GeoTIFF keys of other types.
GeoDoubleParamsTag	34736	Array of DOUBLE	Variable	Contains the value of all GeoTIFF keys of type DOUBLE.
GeoAsciiParamsTag	34737	Array of ASCII	Variable	Contains the value of all GeoTIFF keys of type ASCII.
GTMModelTypeGeoKey	1024	SHORT	2	Model coordinate system. Always set to 2 (Geographic – latitude and longitude – coordinates).
GTRasterTypeGeoKey	1025	SHORT	1	Raster space coordinate system. Always set to 1 (Pixels represent an area in the image).
GTCitationGeoKey	1026	ASCII	“Geo-referenced SAR image”	Description of the configuration of the GeoTIFF. Always set to “Geo-referenced SAR image”.
GeographicTypeGeoKey	2048	SHORT	Variable	Type of geographic coordinate system. Nominally this is set to 4326 for the WGS-84 ellipsoid.

GeoTIFF Tag/Key Name	GeoTIFF Tag/Key Code	Type	Value	Description
GeogCitationGeoKey	2049	ASCII	Variable	Ellipsoid used to geo-reference the image. Nominally this is set to “WGS 84” for the WGS-84 ellipsoid.
GeogLinearUnitsGeoKey	2052	SHORT	9001	Linear units within the coordinate system. Always set to 9001 (metres).
GeogAngularUnitsGeoKey	2054	SHORT	9102	Angular units within the coordinate system. Always set to 9102 (degrees).
GeogEllipsoidGeoKey	2056	SHORT	Variable	Ellipsoid used to geo-reference the image. Nominally this is set to 4326 for the WGS-84 ellipsoid.
GeogSemiMajorAxisGeoKey	2057	DOUBLE	Variable	Equatorial axis in metres. Nominally this is set to 6.378137000000000e+06 for the WGS-84 ellipsoid.
GeogSemiMinorAxisGeoKey	2058	DOUBLE	Variable	Polar axis in metres. Nominally this is set to 6.356752314245000e+06 for the WGS-84 ellipsoid.
GeogInvFlatteningGeoKey	2059	DOUBLE	Variable	Inverse flattening parameter. Nominally this is set to 2.982572235604902e+02 for the WGS-84 ellipsoid.

## 6.2.2 Level 1 Quick-look Image

A Quick-look image is a lower resolution version of the image MDS stored in PNG file format [R-11] and is optionally included with any SM, IW or EW product. Quick-look images are not included with WV mode products. The Quick-look image is used in the Product Preview and is a convenient reference to the complete image MDS. Being of lower resolution it is smaller and can be viewed (loaded) and transferred faster than the complete image MDS. The following rules and properties apply to Quick-look images:

- SM, IW and EW SLC Quick-look images are a power detected, averaged and decimated version of the full SLC image; additionally,
  - Merging is performed (bursts merged in azimuth and swaths merged in range) for IW and EW SLC Quick-look images;
- SM, IW and EW GRD Quick-look images are an averaged and decimated version of the full GRD image;

- Dual polarisation SLC and GRD products contain only one Quick-look image (adhering to the rules above) which is a combination of the imagery from both polarisation channels.

The Quick-look images for single polarisation products are output as greyscale PNG images similar to the ones shown in Figure 6-5.

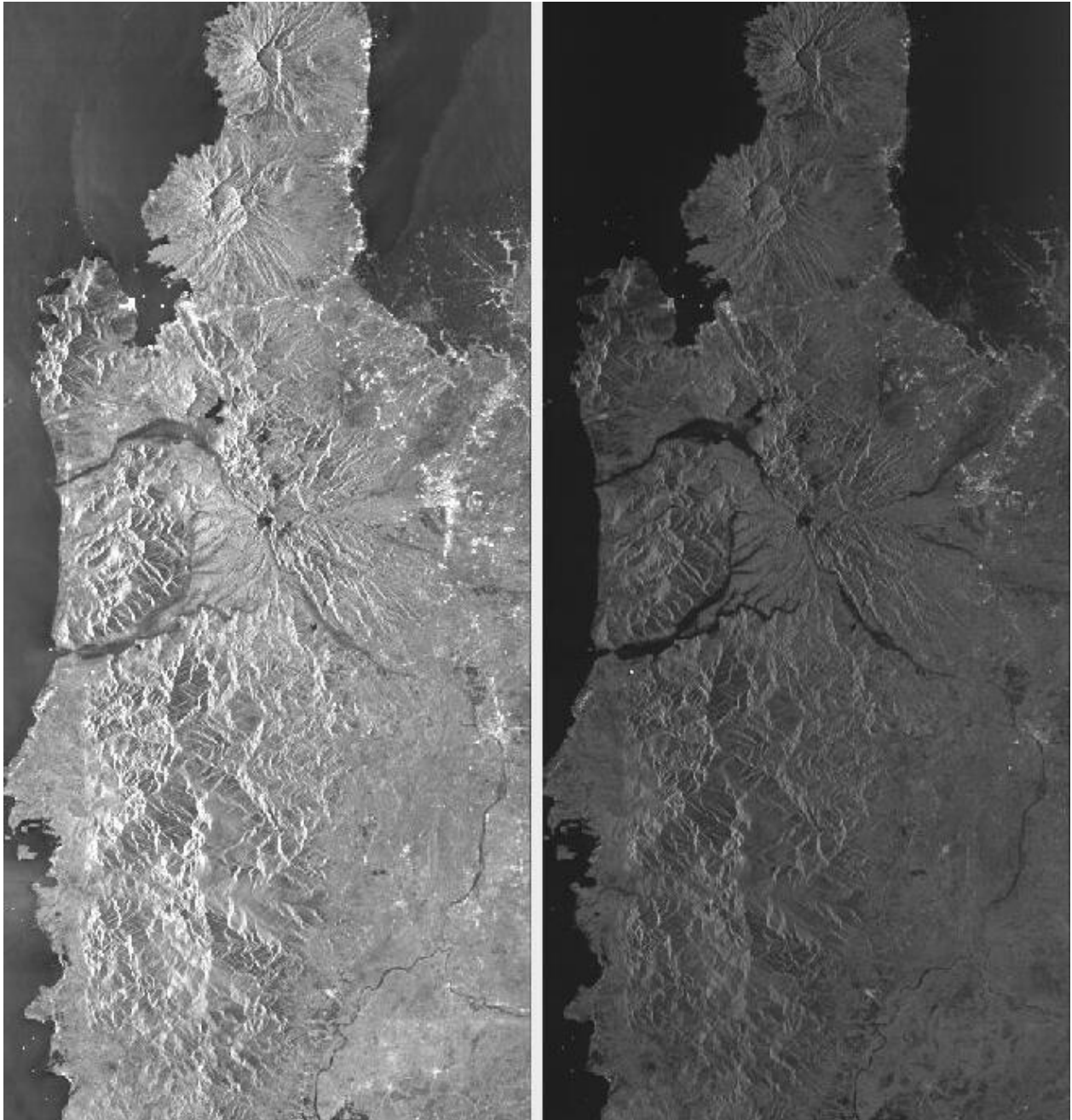

**Figure 6-5 Grey-scale Single Polarisation Quick-look Images: Left VV Co-polarisation and Right VH Cross-polarisation**

For dual polarisation products a single composite image of both polarisations is created using a three channel Red Green Blue (RGB) PNG image similar to the one

shown in Figure 6-6. In composite Quick-look images, the values of the red, green and blue channels are calculated as per Section 7.3.3 of [R-14].

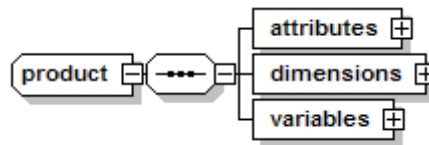

**Figure 6-6 3 Channel (RGB) Composite Dual Polarisation VV/VH Quick-look Image**

## 6.2.3 Level 2 OCN Measurement Data

The Level 2 OCN MDS contains an Ocean Swell Wave spectra component (OSW), an Ocean Wind field component (OWI) and a Radial Surface Velocity component (RVL) estimated from an input L1 SAR image. The format of this data set is a NetCDF file [R-12]. The information in the NetCDF file is broken into three groups – attributes, dimensions and variables – as depicted in Figure 6-7 and described in Table 6-15. The NetCDF format supports the inclusion of both the processed measurement data and the associated metadata within the same file, so the L2 MDS is a self-contained, self-describing file that requires no additional annotations or supporting files.

Note: NetCDF is a binary format and because of its self-describing nature, differs somewhat in format from the other data sets described so far; however, within this section the use of XML diagrams is still employed to present a conceptual view of the structure and content of the Level 2 ocean swell wave spectra and wind field data set. The graphical and tabular views presented below are only conceptual and do not reflect the physical layout of the NetCDF L2 MDS.



**Figure 6-7 L2 OCN Product Top-level Format**

**Table 6-15 L2 OCN Product**

Name	Description	Data Type	Cardinality
attributes	Global attributes annotate variables or files with small notes or supplementary metadata. Attributes are always scalar values or 1D arrays which can be associated with either a variable or the product as a whole.	NetCDF Construct	1
dimensions	Dimensions describe the axes of the data arrays (variables). A dimension has a name and a length.	NetCDF Construct	1
variables	Variables are used to store both the processed L2 measurement data and the associated product annotations. A variable represents an array of values of the same type. A scalar value is treated as a 0-dimensional array. A variable has a name, a data type, and a shape described by its list of dimensions specified when the variable is created.	NetCDF Construct	1

## 6.2.3.1 Global Attributes

Global attributes annotate variables or products with small notes or supplementary metadata. Attributes are always scalar values or 1D arrays which can be associated with either a variable or the product as a whole. The attributes within the L2 MDS annotate basic information about the input and output data.

Figure 6-8 and Table 6-16 present a graphical and tabular view, respectively, of the L2 OCN attributes.

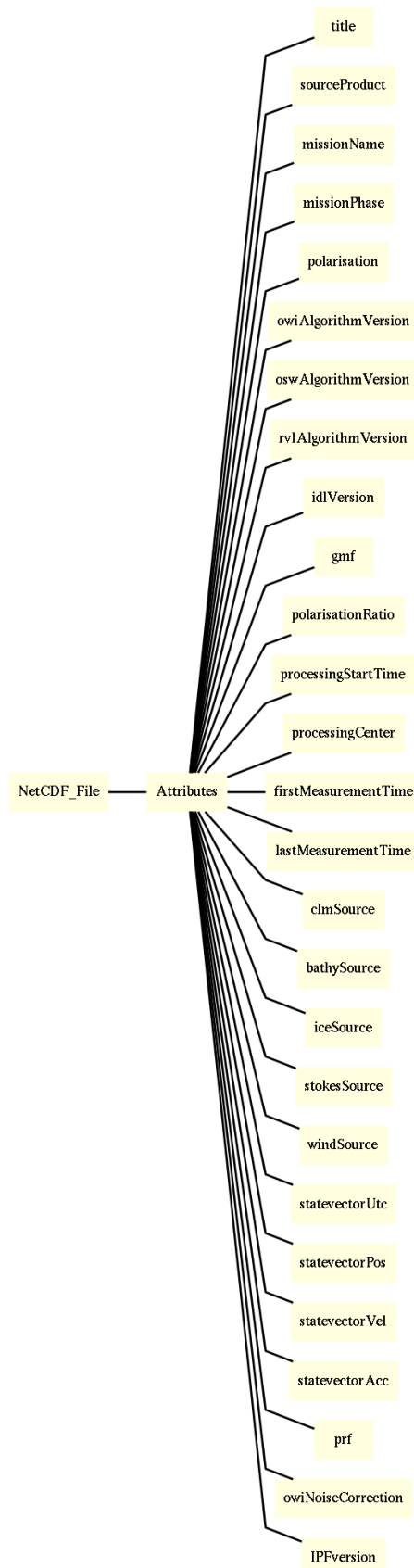

**Figure 6-8 L2 OCN Global Attributes**



**Table 6-16 L2 OCN Global Attributes**

Name	Description	Data Type	Cardinality
title	Title/description of the L2 OCN product.	string	1
sourceProduct	Identifier (file name) of the input L1 product.	string	1
missionName	Identifier of the platform that acquired the SAR data that the L2 OCN product was generated from.	string	1
missionPhase	Phase of the mission (Calibration, Validation, Operational).	string	1
polarisation	Polarisation (“HH”, “VV”, “VV/VH”, “HH/HV”).	string	1
acquisitionStation	Name of the facility that acquired the SAR data (empty string in most situations as the L2 OCN product can be generated from L0 product received at different acquisition stations)	string	0
oswAlgorithmVersion	Version identifier of the OSW algorithm.	string	1
owiAlgorithmVersion	Version identifier of the OWI algorithm.	string	1
rviAlgorithmVersion	Version identifier of the RVL algorithm.	string	1
idlVersion	Version identifier of the IDL software used to generate the L2 OCN product.	string	1
gmf	Geophysical Model Function (GMF) used for OWI processing.	string	1
polarisationRatio	Name and parameters of polarisation ratio used for transforming HH NRCS to VV NRCS before inversion.	string	1
processingStartTime	Start time of L2 processing [UTC].	timeType	1
processingCenter	Name of the processing center where the L2 OCN product was generated.	string	1
firstMeasurementTime	Zero Doppler start time of the source data acquisition [UTC].	timeType	1
lastMeasurementTime	Zero Doppler stop time of the source data acquisition [UTC].	timeType	1
clmSource	Coastline and land masking auxiliary data source.	string	1
bathySource	Bathymetry auxiliary data source.	string	1
iceSource	Ice coverage auxiliary data source. This attribute is set to “None” if the ice auxiliary file is not available.	string	1
stokesSource	Stokes drift auxiliary data source. This attribute is set to “None” if the stokes drif auxiliary file is not available.	string	1

Name	Description	Data Type	Cardinality
windSource	Wind auxiliary data source. This attribute is set to "None" if the wind auxiliary file is not available.	string	1
statevectorUtc	State vector time [UTC].	ISO 8601 timeType	1
statevectorPos	State vector position [m].	double	3
statevectorVel	State vector velocity [m/s].	double	3
statevectorAcc	State vector acceleration [m/s <sup>2</sup> ].	double	3
groundVelocity	Satellite ground velocity [m/s]. This parameter is present for IPF version IPF3.6.0 and later.	float	1
prf	Pulse repetition frequency [Hz].	float	1 .. 5
radarFrequency	Radar signal frequency [Hz]. This parameter is present for IPF version IPF3.6.0 and later.	float	1
raSamplingFreq	Range sampling rate This parameter is present for IPF version IPF3.6.0 and later.	float	1
azSamplingFreq	Azimuth sampling frequency [Hz] This parameter is present for IPF version IPF3.6.0 and later.	float	1
owiNoiseCorrection	Set to 'True' when the noise correction has been activated, otherwise 'False'  owiNoiseCorrection set as True means that the wind inversion process has taken (owiNrcs-owiNesz)>0 as input, otherwise owiNoiseCorrection is False and the OWI inversion process has runned directly from owiNrcs.  This parameter is present from IPF2.70 and later (please note that it is not present in WV products processed by IPF2.7x but introduced after IPF3.30)	bool	1
oswNoiseCorrection	Set to 'True' when the noise correction has been activated, otherwise 'False'  This parameter is present from IPF3.50 and later	bool	1
IPFversion	Version of IPF	string	1
rvlStatus	Status relative to the subtask RVL (wind sub processor): allowed values are 'nominal', 'failed', or 'partial' (ie if not full on all subswath in the case of TOPS mode). This parameter is present for IPF version IPF3.6.0 and later.	string	1
oswStatus	Status relative to the subtask OWI (wind sub processor): allowed values are 'nominal', 'failed', or 'missing' (in case of TOPS, as the Swell subprocess is not launched on this acquisition mode) . This parameter is present for IPF version IPF3.6.0 and later.	string	1

Name	Description	Data Type	Cardinality
owiStatus	Status relative to the subtask OWI (wind sub processor): allowed values are 'nominal', 'failed'. This parameter is present for IPF version IPF3.6.0 and later.	string	1

## 6.2.3.2 Dimensions

Dimensions describe the axes of the data arrays (variables). Each dimension has a name and a length. Within the L2 OCN product, the dimensions are used to define the sizes of the ocean swell wave spectra and wind field grids. Figure 6-9 and Table 6-17 present a graphical and tabular view, respectively, of the L2 OCN dimensions.

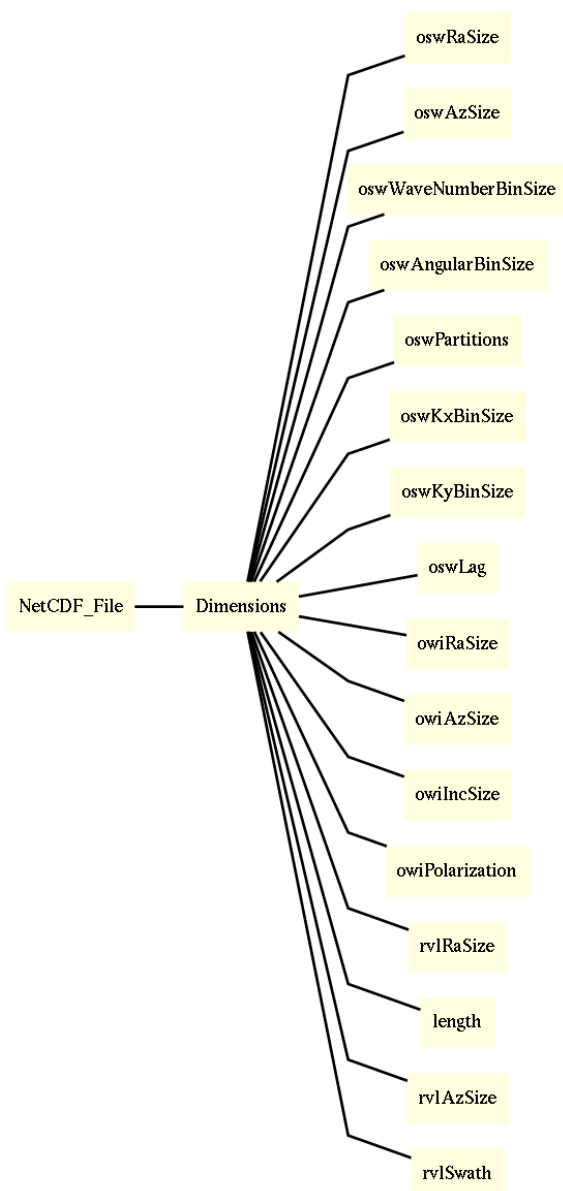

**Figure 6-9 L2 OCN Dimensions**

**Table 6-17 L2 OCN Dimensions**

Name	Description	Data Type	Cardinality
oswRaSize	Number of range swell wave spectra cells. For WV mode this dimension is set to 1 as there is 1 swell wave spectra per WV vignette. For SM this dimension is set to the number of cells in the range direction, nominally 4. This parameter does not apply to IW nor EW mode.	unsignedInt	1
oswAzSize	Number of azimuth swell wave spectra cells. For WV mode this dimension is set to 1 as there is 1 swell wave spectra per WV vignette. For SM this dimension is set to the number of cells in the azimuth direction, nominally 4; although, this will vary with the length of the input image strip. This parameter does not apply to IW nor EW mode.	unsignedInt	1
owiRaSize	Number of range wind cells. For WV mode this dimension is set to 1 as there is 1 wind cell per WV vignette. For SM this dimension is set to the number of cells in the range direction.	unsignedInt	1
owiAzSize	Number of azimuth wind cells. For WV mode this dimension is set to 1 as there is 1 wind cell per WV vignette. For SM this dimension is set to the number of cells in the azimuth direction, this will vary with the length of the input image strip.	unsignedInt	1
owiIncSize	Number of incidence angle vectors.	unsignedInt	1
rvlRaSize	Number of range radial velocity cells. For WV mode this dimension is set to 1 as there is 1 radial velocity cells per WV vignette. For SM this dimension is set to the number of cells in the range direction.	unsignedInt	1
rvlAzSize	Number of azimuth radial velocity cells. For WV mode this dimension is set to 1 as there is 1 radial velocity cells per WV vignette. For SM this dimension is set to the number of cells in the azimuth direction, , this will vary with the length of the input image strip.	unsignedInt	1
oswWavenumberBinSize	Number of wavenumber bins in the swell wave polar spectrum.	unsignedInt	1
oswAngularBinSize	Number of angular bins in the swell wave polar spectrum.	unsignedInt	1
oswPartitions	Number of partitions per swell wave spectra cell.	unsignedInt	1
length	Max length of string variable to store (UTC time)	unsignedInt	1
rvlSwath	Number of swath for EW, IW (not used in SM and WV)	unsignedInt	0..1
owiPolarisation	Number of polarisation in the product	unsignedInt	1
oswKxBinSize	Number of bins in range direction for the cartesian wave spectrum	unsignedInt	1

Name	Description	Data Type	Cardinality
oswKyBinSize	Number of bins in azimuth direction for the cartesian wave spectrum	unsignedInt	1
oswLag	Number of combined cross spectrum	unsignedInt	1

### 6.2.3.3 Variables

Variables are used to store both the processed L2 measurement data and the associated product annotations. A variable represents an array of values of the same type. A scalar value is treated as an array with one element. A variable has a name, a data type, and a shape described by its list of dimensions specified when the variable is created. A graphical view of the L2 OCN variables is presented in Figure 6-10 and:

- Table 6-18 presents the variables in the OSW component grid;
- Table 6-19 presents the variables in the OWI component grid; and
- Table 6-20 presents the variables in the RVL component grid.

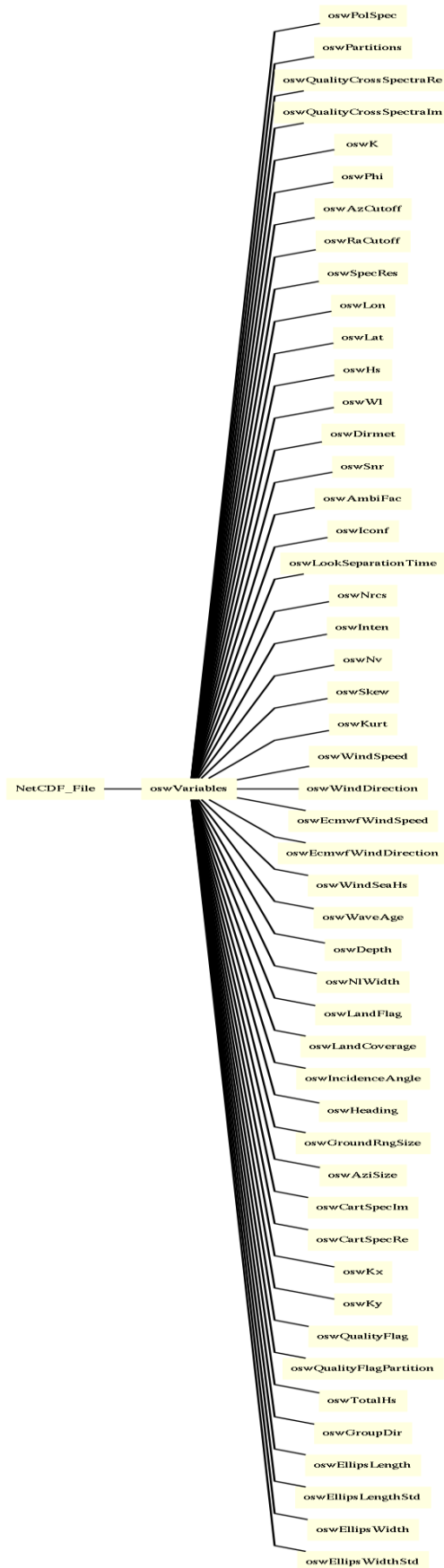
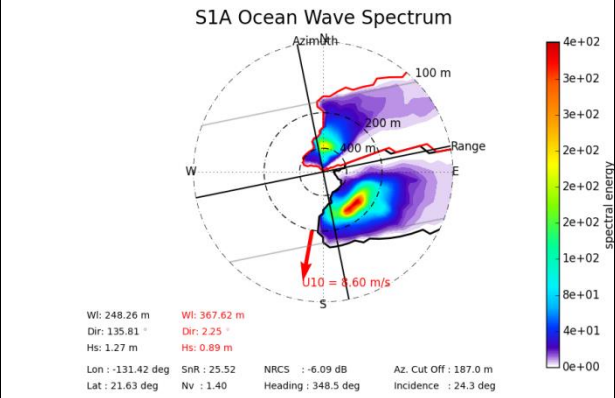

Figure 6-10 L2 OSW Component Variables

**Table 6-18 L2 OSW Component Variables**

Name	Description	Data Type	Cardinality
oswPolSpec	Two-dimensional representation of the ocean swell waveheight spectra in units of [m <sup>4</sup> ] given on a polar grid of wavenumber [rad/m] and angle [degrees]. The dimensions of the matrix are oswAzSize x oswRaSize x oswAngularBinSize x oswWavenumberBinSize.	matrix (float)	1
oswPolSpecNV	Two-dimensional representation of the normalized variance of the ocean swell waveheight spectra [no units] given on a polar grid of wavenumber [rad/m] and angle [degrees]. This variable is estimated as the wave spectra variance among the periodograms within the overall SAR image and normalized by the mean wave spectrum. The dimensions of the matrix are oswAzSize x oswRaSize x oswAngularBinSize x oswWavenumberBinSize.  Applicable from IPF 3.30 and later.	matrix (float)	1
oswPartitions	Two-dimensional representation of the ocean swell wave partitions number given on a polar grid of wavenumber [rad/m] and angle [degrees]. The dimensions of the matrix are oswAzSize x oswRaSize x oswAngularBinSize x oswWavenumberBinSize. Partitions are numbered from 0 to 4 (5 partitions total) and the rest of the wave spectra, if not totally contained in the previous partitions, is set to the fill value.  If part of the wave spectra is filtered due to some low frequency contamination (possibly due to low wind, rain cell, biologic slick...), this region is set in the oswPartitions variable to -1.  An example of partition delineation super-imposed on a wave spectrum is given below. In this case, two partitions are identified, and delineated in red and black lines, on top of the swell spectrum (oswPolSpec). This illustration is extracted from product s1a-wv-ocn-vv-20150501t024410-20150501t024413-005721-007584.SAFE, dataset 095.	matrix (byte)	1



Name	Description	Data Type	Cardinality
oswQualityCrossSpectraRe	Two-dimensional representation of the real part of the quality image cross-spectra parameter [m <sup>2</sup> /rad <sup>2</sup> ] given on a polar grid of wavenumber [rad/m] and angle [degrees]. The dimensions of the matrix are oswAzSize x oswRaSize x oswAngularBinSize x oswWavenumberBinSize.	matrix (float)	1
oswQualityCrossSpectraIm	Two-dimensional representation of the imaginary part of the quality image cross-spectra parameter [m <sup>2</sup> /rad <sup>2</sup> ] given on a polar grid of wavenumber [rad/m] and angle [degrees]. The dimensions of the matrix are oswAzSize x oswRaSize x oswAngularBinSize x oswWavenumberBinSize.	matrix (float)	1
oswK	Array of logarithmically spaced wavenumber bins for the ocean swell wave spectra [rad/m]. The dimension of the array is oswWavenumberBinSize.	array (float)	1
oswPhi	Array of equidistantly spaced directional bins for the ocean swell wave spectra [degrees]. The dimension of the array is oswAngularBinSize.	array (float)	1
oswAzCutoff	The azimuth cut-off wavelength is the shortest wavelength in the azimuth direction that is resolved in the swell wave spectra. The cut-off wavelength in the azimuth direction [m] is computed from the SAR imagette cross-spectra. The Spectral Resolution (specRes) is derived from this parameter. The dimensions of the matrix are oswAzSize x oswRaSize.	matrix (float)	1
oswRaCutoff	The range cut-off wavelength [m] is the shortest wavelength in range direction that can be resolved in the swell wave spectra. The cut-off wavelength is computed from the slant range resolution (or range bandwidth, $f_{sf}$ ) and the local incidence angle as: $\lambda_{range}(\theta) = c/f_{sf} \sin\theta$ The dimensions of the matrix are oswAzSize x oswRaSize	matrix (float)	1
oswSpecRes	The spectral resolution gives the shortest ocean wavelength [m] that can be detected. This depends on the sea state and the wave direction relative to azimuth. This parameter is a vector of wave lengths equal to the number of directional bins. In range, the theoretical limit is given by the range bandwidth, and does not depend on the sea state. $\lambda(\varphi) = (\lambda_c \cdot \cos(\varphi + \varphi_{track})) > \lambda_{min}$ where $\lambda_{min} = 2\pi/k_{max} \approx 30m$ is the shortest wavelength in the spectra. Here $\lambda_c$ is the azimuth cut-off wavelength estimated from the SAR image spectra, and $\varphi_{track}$ is the satellite track heading counter clockwise relative to North. The dimensions of the matrix are oswAzSize x oswRaSize x oswAngularBinSize.	matrix (float)	1
oswLon	Geodetic longitude at wave cell center [degrees_east]. The dimensions of the matrix are oswAzSize x oswRaSize.	matrix (float)	1



Name	Description	Data Type	Cardinality
oswLat	Geodetic latitude at wave cell center [degrees_north]. The dimensions of the matrix are oswAzSize x oswRaSize.	matrix (float)	1
oswHs	The significant wave height computed from the most energetic wave partitions of the swell wave spectra [m]. The dimensions of the matrix are oswAzSize x oswRaSize x oswPartitions.	matrix (float)	1
oswHsNV	The value of the ocean swell spectrum normalized variance computed for the most energetic wave partitions of the swell wave spectra [dimensionless], weighted by the spectral energy. The dimensions of the matrix are oswAzSize x oswRaSize x oswPartitions.  Applicable from IPF 3.30 and later.	matrix (float)	1
oswWl	The dominant wave length of the swell wave spectra [m] for the most energetic wave partitions. The dimensions of the matrix are oswAzSize x oswRaSize x oswPartitions.	matrix (float)	1
oswDirmet	The dominant wave direction of the swell wave spectra [degrees] for the most energetic wave partitions. The dimensions of the matrix are oswAzSize x oswRaSize x oswPartitions.	matrix (float)	1
oswSnr	. This is the signal-to-noise ratio [dB]of the cross-spectra. The dimensions of the matrix are oswAzSize x oswRaSize.	matrix (float)	1
oswAmbiFac	Ambiguity factor [1] measuring the ability to estimate wave propagation direction from the sign of the imaginary part of the cross spectra. The dimensions of the matrix are oswAzSize x oswRaSize x oswPartitions	matrix (float)	1
oswIconf	This flag provides the confidence of the swell wave spectra product for the most energetic wave partitions [0 or 1], where 0 means that the wave direction is resolved while 1 means that there is a 180-degree ambiguity in the wave direction. The dimensions of the matrix are oswAzSize x oswRaSize x oswPartitions.	matrix (byte)	1
oswLookSeparationTime	Separation time between inner and outer look [s]. The dimensions of the matrix are oswAzSize x oswRaSize.	matrix (float)	1
oswNrcs	The normalized radar cross section of the imagette [dB] is the measured radar cross section normalized to the area on ground:  $\sigma^0 = \sigma / A = \sigma \sin \theta / \Delta r \Delta a$ where $\Delta r$ , $\Delta a$ are the slant range and azimuth resolution, respectively. The NRCS is estimated within and provided for each wave cell. The dimensions of the matrix are oswAzSize x oswRaSize.	matrix (float)	1
oswInten	The input SLC image intensity [1] estimated within each wave cell. The dimensions of the matrix are oswAzSize x oswRaSize.	matrix (float)	1

Name	Description	Data Type	Cardinality
oswNv	The variance of the input SLC image normalized by the square of the mean intensity [1] estimated within each wave cell. The dimensions of the matrix are oswAzSize x oswRaSize.	matrix (float)	1
oswSkew	The skewness of the input SLC image [1] estimated within each wave cell. The dimensions of the matrix are oswAzSize x oswRaSize.	matrix (float)	1
oswKurt	The kurtosis of the input SLC image [a1] estimated within each wave cell. The dimensions of the matrix are oswAzSize x oswRaSize.	matrix (float)	1
oswWindSpeed	Wind speed [m/s] used for wave spectral retrieval. This value is derived from the NRCS using the default wind direction (45 degRa) or the value from the European Centre for Medium-Range Weather Forecasts (ECMWF) atmospheric model derived from the L2 auxiliary file. The dimensions of the matrix are oswAzSize x oswRaSize.	matrix (float)	1
oswWindDirection	Wind direction [degrees] used for wave spectral retrieval. This value is derived from the ECMWF atmospheric model derived from the L2 auxiliary file or set to 45deg. The dimensions of the matrix are oswAzSize x oswRaSize.	matrix (float)	1
oswWindSeaHs	The significant wave height for the wind sea part of the total wave height spectrum [m]. Computed from the wind speed and the inverse wave age. The dimensions of the matrix are oswAzSize x oswRaSize.	matrix (float)	1
oswWaveAge	The parameter [1] derived from the SAR data that describes the state of development of the wind sea component of the wave spectra. The dimensions of the matrix are oswAzSize x oswRaSize.	matrix (float)	1
oswEcmwfWindSpeed	Wind speed [m/s] from ECMWF atmospheric model extracted from S1__AUX_WND files. Dimension is oswAzSize x oswRaSize	matrix (float)	1
oswEcmwfWindDirection	Wind direction [degrees_north] from ECMWF atmospheric mode extracted from S1__AUX_WND files. Dimension is oswAzSize x oswRaSize	matrix (float)	1
oswNIWidth	Non-linear inverse spectral width [m] describing non-linear spectral cut-off computed from the cross-spectra. The parameter can be used for calibration and gain monitoring. The dimensions of the matrix are oswAzSize x oswRaSize.	matrix (float)	1
oswDepth	Sea depth [m] from General Bathymetric Chart of Oceans (GEBCO) data set. This parameter is resampled into the wave cell grid. The dimensions of the matrix are oswAzSize x oswRaSize.	matrix (float)	1
oswLandCoverage	Percentage [%] of land coverage within the estimation area. The dimensions of the matrix are oswAzSize x oswRaSize.	matrix (float)	1

Name	Description	Data Type	Cardinality
oswLandFlag	Land mask flag. This flag is set to 1 if the land_coverage > 10%; otherwise, it is set to 0. The dimensions of the matrix are oswAzSize x oswRaSize.	matrix (byte)	1
oswIncidenceAngle	Radar incidence angle [degrees] to the center of the wave cells. This parameter is provided at each azimuth line in the wave cell grid. The dimensions of the matrix are oswAzSize x oswRaSize.	matrix (float)	1
oswHeading	Local Northing angle [degrees]. The dimensions of the matrix are oswAzSize x oswRaSize.	matrix (float)	1
oswGroundRngSize	Ground range size of the estimation area [m]. The dimensions of the matrix are oswAzSize x oswRaSize.	matrix (float)	1
oswAziSize	Azimuth size of the estimation area [m]. The dimensions of the matrix are oswAzSize x oswRaSize.	matrix (float)	1
oswCartSpecRe	Real part of the Cathesian cross spectra [m <sup>4</sup> ]. Half of the full Cartesian cross spectra are stored (full frequencies in azimuth direction and only positive frequencies in range direction) to be symmetrized. The dimensions of the matrix are oswAzSize x oswRaSize x oswKyBinSize x oswKxBinSize x oswLag. <ul style="list-style-type: none"> <li>- Zeros time lag= co-spectra: average cross spectra of subviews 0-0, 1-1 and 2-2.</li> <li>- First time lag= average cross spectra of subviews 0-1 and 1-2</li> <li>- Second time lag= cross spectra of subviews 0-2</li> </ul>	matrix (float)	1
oswCartSpecIm	Imaginary part of the Cartesian cross spectra [m <sup>4</sup> ]. Half of the full Cartesian cross spectra are stored (full frequencies in azimuth direction and only positive frequencies in range direction) to be symmetrized. The dimensions of the matrix are oswAzSize x oswRaSize x oswKyBinSize x oswKxBinSize x oswLag. <ul style="list-style-type: none"> <li>- Zeros time lag= co-spectra: average cross spectra of subviews 0-0, 1-1 and 2-2.</li> <li>- First time lag= average cross spectra of subviews 0-1 and 1-2</li> <li>- Second time lag= cross spectra of subviews 0-2</li> </ul>	matrix (float)	1
oswKx	Normalized Array of spacial frequency bins in range direction for the carthesian cross spectra [m/m], half the array is presented corresponding to positive frequencies. The dimension of the array is oswKxBinSize  The oswKx array has been normalized by oswGroundRngSize variable and has to be divided by this later in order to get the actual spacial frequency vector for the given imagette.	Array (float)	1

Name	Description	Data Type	Cardinality
oswKy	<p>Normalized Array of spacial frequency bins in Azimuth direction for the carthesian cross spectra [m/m]. The dimension of the array is oswKyBinSize</p> <p>The oswKy array has been normalized by oswAziSize variable and has to be divided by this later in order to get the actual spacial frequency vector for the given imagette.</p>	matrix (float)	1
oswJx	<p>Normalised Jacobian array in range direction describing the non linear resampling transformation for the carthesian cross spectra [m/m], half the array is presented corresponding to positive frequencies. The dimension of the array is oswKxBinSize</p> <p>The oswJx array has been normalized by oswGroundRngSize variable and has to be divided by this later in order to get the actual Jacobian vector for the given imagette.</p>	matrix (float)	1
oswJy	<p>Normalised Jacobian array in range direction describing the non linear resampling transformation for the carthesian cross spectra [m/m]. The dimension of the array is oswKyBinSize</p> <p>The oswJy array has been normalized by oswAziSize variable and has to be divided by this later in order to get the actual Jacobian vector for the given imagette.</p>	matrix (float)	1
oswTotalHs	<p>Total significant wave height [m]. The dimensions of the matrix are oswAzSize x oswRaSize  oswTotalHs and oswTotalHsStdev retrieval are based on a statistical approach. The relationship between Sentinel-1 radar parameters and reference Hs as provided by altimeters has been learned empirically off line using a Deep learning approach. This relation has been implemented in the IPF and is then applied at each imagette to provide an estimate of the significant wave height and its standard deviation. Here the significant wave height aims at being similar than the significant wave height as measured by altimeters. These variables are qualified as "total" to avoid any confusion with oswHs variable that is already used for the significant wave height for each wave partition in the product.</p> <p>WV: One value per imagette  Introduced in IPF 3.3x</p>	matrix(float)	1
oswTotalHsStdev	<p>Standard deviation of oswTotalHs estimate [m].</p> <p>The dimensions of the matrix are oswAzSize x oswRaSize</p> <p>Refer to oswTotaHs for the meaning of this variable.</p> <p>WV: One value per imagette.  Introduced in IPF 3.40</p>	matrix(float)	1

Name	Description	Data Type	Cardinality
oswQualityFlagPartition	Quality flag for the integral parameters (oswHs, oswWl and oswDirmet) of each partition. The dimensions of the matrix are oswAzSize x oswRaSize x oswPartitions  Swell quality flag values can be 0 (very good), 1 (good), 2 (medium), 3 (low), 4 (poor).	matrix(byte)	1
oswQualityFlag	Quality flag of the directional swell spectrum (oswPolSpec). The dimensions of the matrix are oswAzSize x oswRaSize.  Swell quality flag values can be 0 (high quality), 1 (medium quality), 2 (low quality) or 3 (bad quality).  WV: One value per imagette.	matrix(byte)	1
oswGroupDir	Swell direction estimated from the Group analysis [degrees]. The dimensions of the matrix are oswAzSize x oswRaSize x oswPartitions.	matrix(float)	1
oswEllipsLength	Length of the major axis of the ellipsoid [m]. A parameter of the estimated fitting ellipsoid for Group analysis. The dimensions of the matrix are oswAzSize x oswRaSize x oswPartitions.	matrix(float)	1
oswEllipsLengthStdDev	Standard deviation around major axis of the ellipsoid [m]. A parameter of the estimated fitting ellipsoid for Group analysis. The dimensions of the matrix are oswAzSize x oswRaSize x oswPartitions.	matrix(float)	1
oswEllipsWidth	Length of the minor axis of the ellipsoid [m]. A parameter of the estimated fitting ellipsoid for Group analysis. The dimensions of the matrix are oswAzSize x oswRaSize x oswPartitions.	matrix (float)	1
oswEllipsWidthStdDev	Standard deviation around major axis of the ellipsoid [m]. parameters of the estimated ellipsoid for Group analysis. The dimensions of the matrix are oswAzSize x oswRaSize x oswPartitions.	matrix(float)	1
oswNrCsNesZCorr	The noise corrected NRCS [m <sup>2</sup> /m <sup>2</sup> ]. The dimensions of the matrix are oswAzSize x oswRaSize.  Variables introduced after IPF 3.50	matrix (float)	1
oswPclut1	Estimated clutter noise levels of the cross-covariance spectra. The dimensions of the matrix are oswAzSize x oswRaSize x oswLag.  This variable is present for IPF version IPF3.6.0 and later.	matrix (float)	1
oswPclut2	Estimated clutter noise levels on cross spectra from which low frequency signal is removed. The dimensions of the matrix are oswAzSize x oswRaSize x oswLag.  This variable is present for IPF version IPF3.6.0 and later.	matrix (float)	1



# Sentinel-1

Ref: S1-RS-MDA-52-7441  
MPC Nom: DI-MPC-PB  
MPC Ref: MPC-0240  
Issue/Revision: 3/12  
Date: 19/09/2022

Name	Description	Data Type	Cardinality
oswRaSizeSLC	Size of SLC swath over Range dimension .The dimensions of the matrix are oswAzSize x oswRaSize. This variable is present for IPF version IPF3.6.0 and later.	matrix (float)	1
oswAzSizeSLC	Size of SLC swath over Azimuth dimension. The dimensions of the matrix are oswAzSize x oswRaSize. This variable is present for IPF version IPF3.6.0 and later.	matrix (float)	1

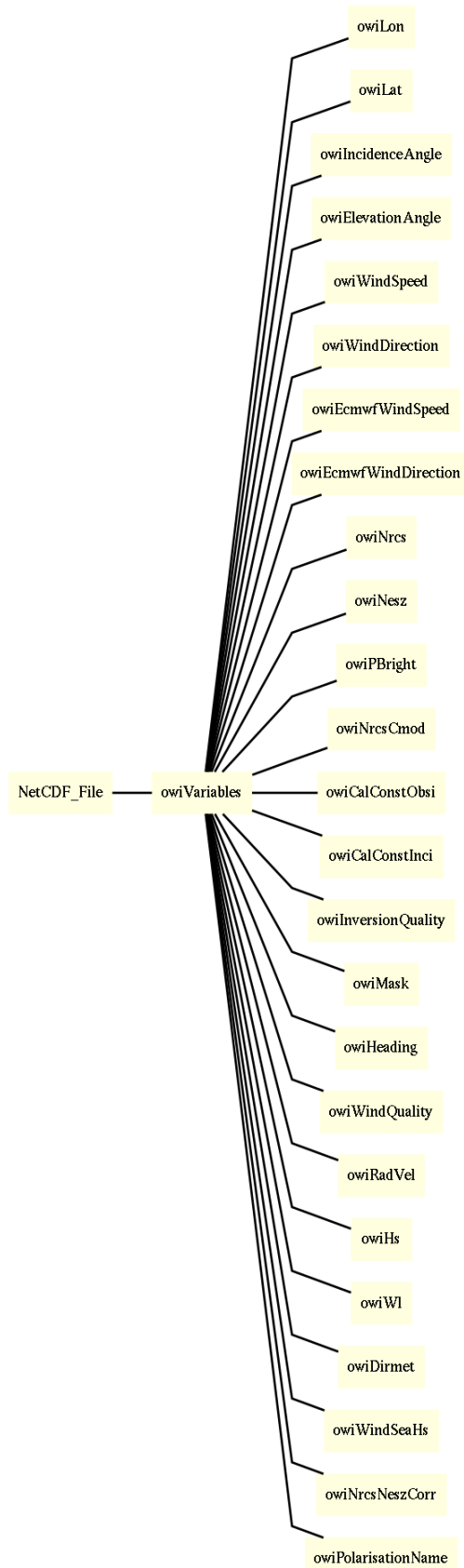

**Figure 6-11 L2 OWI Component Variables**

**Table 6-19 L2 OWI Component Variables**

Name	Description	Data Type	Cardinality
owiLon	Geodetic longitude at wind cell center [degrees_east]. The dimensions of the matrix are owiAzSize x owiRaSize.	matrix (float)	1
owiLat	Geodetic latitude at wind cell center [degrees_north]. The dimensions of the matrix are owiAzSize x owiRaSize.	matrix (float)	1
owiLandFlag	Land mask flag. This flag is set to 1 if the land_coverage > 10%; otherwise, it is set to 0. The dimensions of the matrix are owiAzSize x owiRaSize.  Please note that this flag is not present for product of IPF 2.90 and later	matrix (byte)	0,1
owiMask	Owi mask. The dimensions of the matrix are owiAzSize x owiRaSize . Byte value:  0: useful data  1:land mask: set to 1 if the land_coverage > 10%  2: ice mask: Extended IceMask (10km dilated ice edge area)  4: missing data	Matrix (byte)	1
owiIncidenceAngle	Radar incidence angle [degrees] to the center of the wind cells. This parameter is provided at each azimuth line in the wind cell grid. The dimensions of the matrix are owiAzSize x owiRaSize.	matrix (float)	1
owiHeading	Local Northing angle [degrees]. The dimensions of the matrix are owiAzSize x owiRaSize.	matrix (float)	1
owiNrsc	The normalized radar cross section of the imagette [m <sup>2</sup> /m <sup>2</sup> ] is the measured radar cross section normalized to the area on ground:  $\sigma^0 = \sigma / A = \sigma \sin \theta / \Delta r \Delta a$ where $\Delta r$ , $\Delta a$ are the slant range and azimuth resolution, respectively. The NRCS is estimated within and provided for each wind cell. The dimensions of the matrix are owiAzSize x owiRaSize x owiPolarisation.	matrix (float)	1
owiNrscNeszCorr	The noise corrected NRCS [m <sup>2</sup> /m <sup>2</sup> ] averaged within and provided for each wind cell. The dimensions of the matrix are owiAzSize x owiRaSize x owiPolarisation.	matrix (float)	1
owiPBright	Percentage of bright targets pixels detected in each SAR wind cell and removed for the computation of the mean NRCS [%]. The dimensions of the matrix are owiAzSize x owiRaSize.	matrix (float)	1
owiNrscCmod	Predicted NRCS from CMOD and ECMWF a priori 10m wind for each SAR wind cell [m <sup>2</sup> /m <sup>2</sup> ]. The dimensions of the matrix are owiAzSize x owiRaSize.	matrix (float)	1



Name	Description	Data Type	Cardinality
owiCalConstObsi	Geophysical calibration constant estimated for each L2 OCN product from ECMWF ancillary wind field and CMOD GMF used for wind retrieval. The dimension of the vector is owiIncSize.	vector (float)	1
owiCalConstInci	Incidence angles [degrees] vector corresponding to the Geophysical calibration constant vector. The dimension of the vector is owiIncSize.	vector (float)	1
owiWindSpeed	SAR wind speed for each wind cell [m/s]. The dimensions of the matrix are owiAzSize x owiRaSize.	matrix (float)	1
owiWindDirection	SAR wind direction for each wind cell [degrees]. The dimensions of the matrix are owiAzSize x owiRaSize.	matrix (float)	1
owiInversionQuality	<p>Inversion quality indicator for each wind cell. The dimensions of the matrix are owiAzSize x owiRaSize.</p> <p>owiInversionQuality flag is related to the wind inversion step relying on the NRCS, the incidence angle, azimuth look angle and ancillary wind speed and direction. If the NRCS, the incidence and azimuth look angles are correct, then it is expected that the SAR wind will be consistent with the ancillary wind. The owiInversionQuality flag is an indication of this consistency between SAR and ancillary winds. The values are as followed:</p> <p>Inversion quality flag values can be 0 (high quality), 1 (medium quality) or 2 (low quality)</p> $\text{if, } \left   u_{\text{SAR}}  -  u_{\text{ECMWF}}  \right  < T_i, \text{ then } Q_i = 0$ $\text{if, } T_i \leq \left   u_{\text{SAR}}  -  u_{\text{ECMWF}}  \right  < 2T_i, \text{ then } Q_i = 1$ $\text{if, } \left   u_{\text{SAR}}  -  u_{\text{ECMWF}}  \right  \geq 2T_i, \text{ then } Q_i = 2$ <p>Where <math>T_i</math> is a configurable auxiliary input parameter with a default value of 1.5.</p>	matrix (byte)	1
owiWindQuality	<p>SAR wind quality flag for each wind cell. The dimensions of the matrix are owiAzSize x owiRaSize.</p> <p>The owiWindQuality flag <math>Q_w</math> is more general than the owiInversionQuality. This flag includes the inversion quality but also the geophysical quality flag found for the whole product and the quality of the NRCS estimated for each wind vector cell. This quality depends on the percentage of bright targets found among the pixels included in each wind vector cell.</p> <p>Wind quality flag values can be 0 (high quality), 1 (medium quality), 2 (low quality) or 3 (bad quality).</p> <p>The quality of the of the NRCS is evaluated as followed:</p>	matrix (byte)	1

Name	Description	Data Type	Cardinality
	<p>if, <math>P_{\text{bright}} &lt; T_b</math>, then <math>Q_b = 0</math>, (good)</p> <p>if, <math>P_{\text{bright}} &gt; T_b</math>, then <math>Q_b = 1</math>. (bad)</p> <p>Where <math>T_b</math> is a configurable auxiliary input parameters with a default value of 500.</p> <p>If the geophysical calibration of the whole product has been found bad then:</p> <p><math>Q_w = 3</math></p> <p>if, <math>Q_i = 2</math>, then <math>Q_w = 2</math>,</p> <p>if, <math>Q_i = 1</math> and <math>Q_b = 1</math>, then <math>Q_w = 2</math>,</p> <p>if, <math>Q_i = 1</math> and <math>Q_b = 0</math>, then <math>Q_w = 1</math>,</p> <p>if, <math>Q_i = 0</math> and <math>Q_b = 0</math>, then <math>Q_w = 0</math></p>		
owiEcmwfWindSpeed	Wind speed [m/s] from the European Centre for Medium-Range Weather Forecasts (ECMWF) atmospheric model derived from the L2 auxiliary file and resampled into wind cell grid. The dimensions of the matrix are owiAzSize x owiRaSize.	matrix (float)	1
owiEcmwfWindDirection	Wind direction [degrees] from ECMWF atmospheric model derived from the L2 auxiliary file and resampled into the wind cell grid. The dimensions of the matrix are owiAzSize x owiRaSize.	matrix (float)	1
owiRadVel	Radial velocities [m/s] from the RVL component interpolated to the wind cell grid. The dimensions of the matrix are owiAzSize x owiRaSize.	matrix (float)	1
owiHs	The significant wave height [m] from the OSW component interpolated to the wind cell grid. The dimensions of the matrix are: for WV/SM, owiAzSize x owiRaSize x oswPartitions. For IW/EW, as OSW is not performed, the variable is fillvalue with dimensions oswAzSize x oswRaSize x oswPartitions (1x 1x1).	matrix (float)	1
owiWl	The dominant wave length [m] from the OSW component interpolated to the wind cell grid. The dimensions of the matrix are: for WV/SM, owiAzSize x owiRaSize x oswPartitions. For IW/EW, as OSW is not performed, the variable is fillvalue with dimensions oswAzSize x oswRaSize x oswPartitions (i.e. 1x 1x1).	matrix (float)	1
owiDirmet	The dominant wave direction [degrees] from the OSW component interpolated to the wind cell grid. The dimensions of the matrix are, for WV/SM, owiAzSize x owiRaSize x oswPartitions. For IW/EW, as OSW is not performed, the variable is fillvalue with dimensions oswAzSize x oswRaSize x oswPartitions (i.e.; 1x 1x1).	matrix (float)	1

Name	Description	Data Type	Cardinality
owiWindSeaHs	The significant wave height for the wind sea part of the total wave height spectrum [m] from the OSW component interpolated to the wind cell grid. The dimensions of the matrix are: for WV/SM owiAzSize x owiRaSize. For IW/EW, as OSW is not performed, the variable is fillvalue with dimensions, oswAzSize x oswRaSize (1x 1 and fillvalue).	matrix (float)	1
owiElevationAngle	Radar elevation angle [degrees] to the center of the wind cells. This parameter is provided at each azimuth line in the wind cell grid.  The dimensions of the matrix are owiAzSize x owiRaSize.	matrix (float)	1
owiNesz	The noise equivalent sigmaNaught, dimension is equivalent to measured radar cross section normalized to the area on ground [m <sup>2</sup> /m <sup>2</sup> ]. The owiNesz is a copy of the calibrated Noise LUT annotated in the Level1 interpolated on the wind cell grid.  The dimensions of the matrix are owiAzSize x owiRaSize x owiPolarisation.	matrix (float)	1
owiPolarisationName	The name of the receiving polarization in order to discriminate the co and cross polarisation. The dimension is owiPolarisation	Array(byte)	1

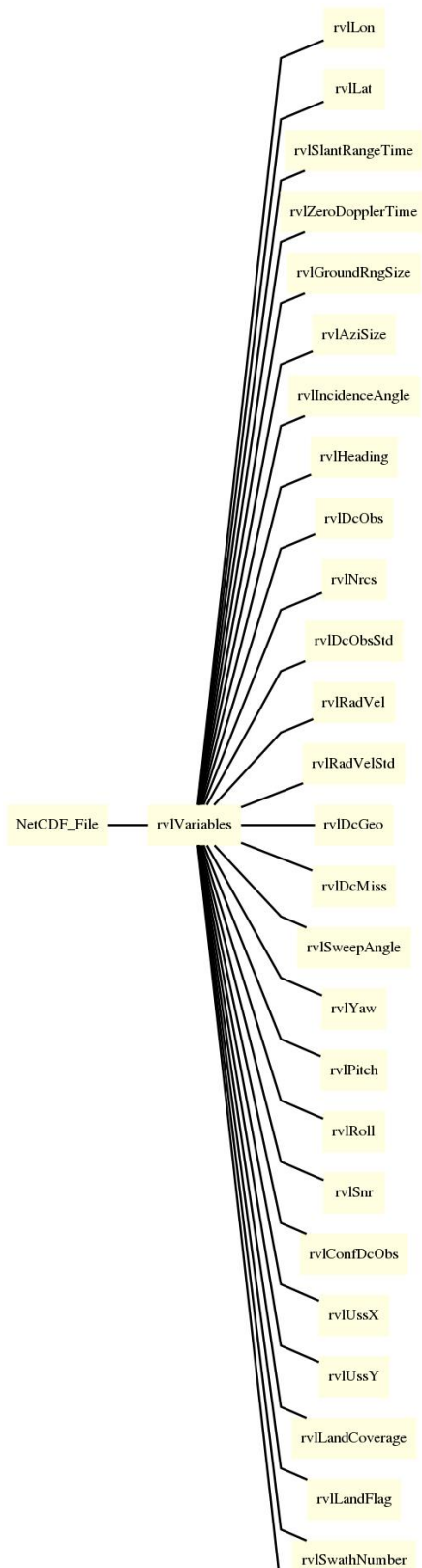

**Figure 6-12 L2 RVL Component Variables**

**Table 6-20 L2 RVL Component Variables**

Name	Description	Data Type	Cardinality
rvlLon	Geodetic longitude at RVL cell center [degrees_east]. The dimensions of the matrix are: for SM/WV, rvlAziSize x rvlRaSize; for EW/IW, rvlAziSize x rvlRaSize x rvlSwath;	matrix (float)	1
rvlLat	Geodetic latitude at RVL cell center [degrees_north]. The dimensions of the matrix are; for SM/WV, rvlAziSize x rvlRaSize; for EW/IW, rvlAziSize x rvlRaSize x rvlSwath;	matrix (float)	1
rvlLandCoverage	Percentage [%] of land coverage within the estimation area. The dimensions of the matrix are ; for SM/WV, rvlAziSize x rvlRaSize; for EW/IW, rvlAziSize x rvlRaSize x rvlSwath.	matrix (float)	1
rvlLandFlag	Land mask flag This flag is set to 1 if the land_coverage > 10%; otherwise, it is set to 0. The dimensions of the matrix are : for SM/WV, rvlAziSize x rvlRaSize; for EW/IW, rvlAziSize x rvlRaSize x rvlSwath..	matrix (byte)	1
rvlIncidenceAngle	Radar incidence angle [degrees] to the center of the RVL cells. This parameter is provided at each azimuth line in the radial velocity cell grid. The dimensions of the matrix are : for SM/WV, rvlAziSize x rvlRaSize; for EW/IW, rvlAziSize x rvlRaSize x rvlSwath.	matrix (float)	1
rvlHeading	Local Northing angle [degrees]. The dimensions of the matrix are : for SM/WV, rvlAziSize x rvlRaSize; for EW/IW, rvlAziSize x rvlRaSize x rvlSwath.	matrix (float)	1
rvlNrsc	Normalized radar cross-section [m <sup>2</sup> /m <sup>2</sup> ], side-band corrected signal intensity. The intensity is estimated within and provided for each radial velocity cell. The dimensions of the matrix are: for SM/WV, rvlAziSize x rvlRaSize; for EW/IW, rvlAziSize x rvlRaSize x rvlSwath.	matrix (float)	1
rvlDcObs	Estimated Doppler centroid frequency [Hz]. The dimensions of the matrix are : for SM/WV, rvlAziSize x rvlRaSize; for EW/IW, rvlAziSize x rvlRaSize x rvlSwath;	array (float)	1
rvlDcObsStd	Estimated Doppler frequency standard deviation [Hz]. The dimensions of the matrix are: for SM/WV, rvlAziSize x rvlRaSize; for EW/IW, rvlAziSize x rvlRaSize x rvlSwath;	array (float)	1
rvlConfDcObs	Confidence in the Doppler centroid frequency estimates. The dimensions of the matrix are : for SM/WV, rvlAziSize x rvlRaSize; for EW/IW, rvlAziSize x rvlRaSize x rvlSwath.	matrix (byte)	1
rvlRadVel	Radial velocities [m/s]. The dimensions of the matrix are: for SM/WV, rvlAziSize x rvlRaSize; for EW/IW, rvlAziSize x rvlRaSize x rvlSwath.	matrix (float)	1

Name	Description	Data Type	Cardinality
rvlRadVelStd	Standard deviation of radial velocities [m/s]. The dimensions of the matrix are : for SM/WV, rvlAziSize x rvlRaSize; for EW/IW, rvlAziSize x rvlRaSize x rvlSwath;.	matrix (float)	1
rvlDcGeo	Doppler centroid frequency from geometry [Hz]. This parameter is interpolated from the L1 product. The dimensions of the matrix are : for SM/WV, rvlAziSize x rvlRaSize; for EW/IW, rvlAziSize x rvlRaSize x rvlSwath;.	matrix (float)	1
rvlDcMiss	Doppler centroid frequency from antenna miss-pointing [Hz]. The dimensions of the matrix are : for SM/WV, rvlAziSize x rvlRaSize; for EW/IW, rvlAziSize x rvlRaSize x rvlSwath;.	matrix (float)	1
rvlYaw	Yaw [degrees] of satellite platform versus zero Doppler time. The dimensions of the matrix are: for SM/WV, rvlAziSize x rvlRaSize; for EW/IW, rvlAziSize x rvlRaSize x rvlSwath;.	matrix (float)	1
rvlPitch	Pitch [degrees] of satellite platform versus zero Doppler time. The dimensions of the matrix are : for SM/WV, rvlAziSize x rvlRaSize; for EW/IW, rvlAziSize x rvlRaSize x rvlSwath.	matrix (float)	1
rvlRoll	Roll [degrees] of satellite platform versus zero Doppler time. The dimensions of the matrix are : for SM/WV, rvlAziSize x rvlRaSize; for EW/IW, rvlAziSize x rvlRaSize x rvlSwath.	matrix (float)	1
rvlSnr	Signal to noise ratio estimated from Doppler spectra (side-band corrected intensity/additive noise) [1]. The dimensions of the matrix are : for SM/WV, rvlAziSize x rvlRaSize; for EW/IW, rvlAziSize x rvlRaSize x rvlSwath.	matrix (float)	1
rvlUssX	Longitudinal component of surface stokes drift [m/s] from WAVEWATCH III model. The dimensions of the matrix are : for SM/WV, rvlAziSize x rvlRaSize; for EW/IW, rvlAziSize x rvlRaSize x rvlSwath.	matrix (float)	1
rvlUssY	Meridional component of surface stokes drift [m/s] from WAVEWATCH III model. The dimensions of the matrix are : for SM/WV, rvlAziSize x rvlRaSize; for EW/IW, rvlAziSize x rvlRaSize x rvlSwath..	matrix (float)	1
rvlSweepAngle	Sweep angle of the TOPS mode [degrees]. The dimensions of the matrix are : for SM/WV, rvlAziSize x rvlRaSize; for EW/IW, rvlAziSize x rvlRaSize x rvlSwath.	matrix (float)	1
rvlSlantRangeTime	Slant range time [s]. The dimensions of the matrix are: for SM/WV, rvlAziSize x rvlRaSize; for EW/IW, rvlAziSize x rvlRaSize x rvlSwath.	matrix (float)	1
rvlZeroDopplerTime	Zero Doppler time. The dimensions of the matrix are: for SM/WV, rvlAziSize x rvlRaSize x length; for EW/IW, rvlAziSize x rvlRaSize x length x rvlSwath.	matrix (timeType)	1

Name	Description	Data Type	Cardinality
rvlGroundRngSize	Ground range resolution [m]. The pixel size is half this value. The dimensions of the matrix are: for SM/WV, rvlAziSize x rvlRaSize; for EW/IW, rvlAziSize x rvlRaSize x rvlSwath.	matrix (float)	1
rvlAziSize	Azimuth resolution [m]. The pixel size is half this value. The dimensions of the matrix are: for SM/WV, rvlAziSize x rvlRaSize; for EW/IW, rvlAziSize x rvlRaSize x rvlSwath.	matrix (float)	1
rvlSwathNumber	Swath number The dimension of the array is rvlSwath	Array(byte)	1: for EW/IW 0: for SM/WV

## 6.2.3.4 Variables attributes

The variables described in section 6.2.3.3 provide as well a set of variable attributes.

The supported attributes are the following:

- standard\_name: corresponds to standard\_name from the CF convention (when available)
- valid\_range: corresponds to the valid range of values (refer to CF convention)
- long\_name : long name (human readable)
- flag\_meaning : contains the meaning of each possible value of the flag (refer to CF convention)
- units : unit of the measurement
- flag\_values: contains the list of possible flag values (refer to CF convention)
- \_FillValue : contains the value used to indicate missing data
- scaled : if set to yes, indicates that the scaling/normalisation was applied as post processing

The list of attributes present for each variable is described in following table.

**Table 6-21 L2 attributes for each variable**

variable name	standard_name	valid_range	long_name	flag_meanings	units	flag_values	_FillValue	Scaled
owiRadVel			x		x		x	
owiHs			x		x		x	

owiWI			X		X		X	
owiDirmet			X		X		X	
owiWindSeaHs			X		X		X	
owiLon	X		X		X			
owiLat	X		X		X			
owiIncidenceAngle			X		X			
owiElevationAngle			X		X			
owiWindSpeed	X		X		X		X	
owiWindDirection	X		X		X		X	
owiEcmwfWindSpeed	X		X		X			
owiEcmwfWindDirection	X		X		X			
owiNrcs			X		X		X	
owiNesz			X		X		X	
owiPBright		X	X		X		X	
owiNrcsCmod			X		X		X	
owiCalConstObsi			X				X	
owiCalConstInci			X		X			
owiInversionQuality		X	X	X		X	X	
owiMask		X	X	X		X		
owiHeading			X		X		X	
owiWindQuality		X	X	X		X	X	
owiNrcsNeszCorr			X		X		X	
owiPolarisationName			X	X		X	X	
rvlLon	X		X		X		X	
rvlLat	X		X		X		X	
rvlLandCoverage		X	X		X		X	
rvlLandFlag		X	X	X		X	X	
rvlIncidenceAngle			X		X		X	
rvlHeading			X		X		X	
rvlNrcs			X		X		X	X
rvlDcObs			X		X		X	
rvlDcObsStd			X		X		X	
rvlRadVel			X		X		X	
rvlRadVelStd			X		X		X	
rvlDcGeo			X		X		X	
rvlDcMiss			X		X		X	
rvlConfDcObs		X	X	X		X	X	
rvlUssX			X		X		X	
rvlUssY			X		X		X	
rvlPitch			X		X		X	
rvlYaw			X		X		X	
rvlRoll			X		X		X	
rvlSnr			X		X		X	





# Sentinel-1

Ref: S1-RS-MDA-52-7441  
 MPC Nom: DI-MPC-PB  
 MPC Ref: MPC-0240  
 Issue/Revision: 3/12  
 Date: 19/09/2022

rviSweepAngle			x		x		x	
rviSlantRangeTime			x		x		x	
rviZeroDopplerTime			x				x	
rviGroundRngSize			x		x		x	
rviAziSize			x		x		x	
oswPolSpec			x		x			
oswPolSpecNV			x		x			
oswPartitions			x		x		x	
oswQualityCrossSpectraRe			x		x			
oswQualityCrossSpectraIm			x		x			
oswK			x		x			
oswPhi			x		x			
oswAzCutoff			x		x			
oswRaCutoff			x		x			
oswSpecRes			x		x			
oswLon	x		x		x			
oswLat	x		x		x			
oswHs			x		x		x	
oswHsNV			x		x		x	
oswWl			x		x		x	
oswDirmet			x		x		x	
oswSnr			x		x			
oswAmbiFac			x		x		x	
oswIconf		x	x	x		x	x	
oswLookSeparationTime			x		x			
oswNrcs			x		x			
oswNrcsNeszCorr			x		x			
oswInten			x		x			
oswNv			x		x			
oswSkew			x		x			
oswKurt			x		x			
oswWindSpeed			x		x			
oswWindDirection			x		x			
oswEcmwfWindSpeed			x		x			
oswEcmwfWindDirection			x		x			
oswWindSeaHs			x		x			
oswWaveAge			x		x			
oswDepth			x		x			
oswNIWidth			x		x			
oswLandFlag		x	x	x		x		
oswLandCoverage		x	x		x			
oswIncidenceAngle			x		x			
oswHeading			x		x			



# Sentinel-1

Ref: S1-RS-MDA-52-7441  
 MPC Nom: DI-MPC-PB  
 MPC Ref: MPC-0240  
 Issue/Revision: 3/12  
 Date: 19/09/2022

oswGroundRngSize			X		X			
oswAziSize			X		X			
oswEllipsLength			X		X		X	
oswEllipsLengthStdDev			X		X		X	
oswEllipsWidth			X		X		X	
oswEllipsWidthStdDev			X		X		X	
oswGroupDir			X		X		X	
oswQualityFlagPartition		X	X	X		X	X	
oswQualityFlag		X	X	X		X	X	
oswTotalHs			X		X		X	
oswTotalHsStdev			X		X		X	
oswCartSpecIm			X		X		X	
oswCartSpecRe			X		X		X	
oswKx			X		X		X	
oswKy			X		X		X	
oswJx			X		X		X	
oswJy			X		X		X	

## 6.2.4 Level 2 Quick-look images

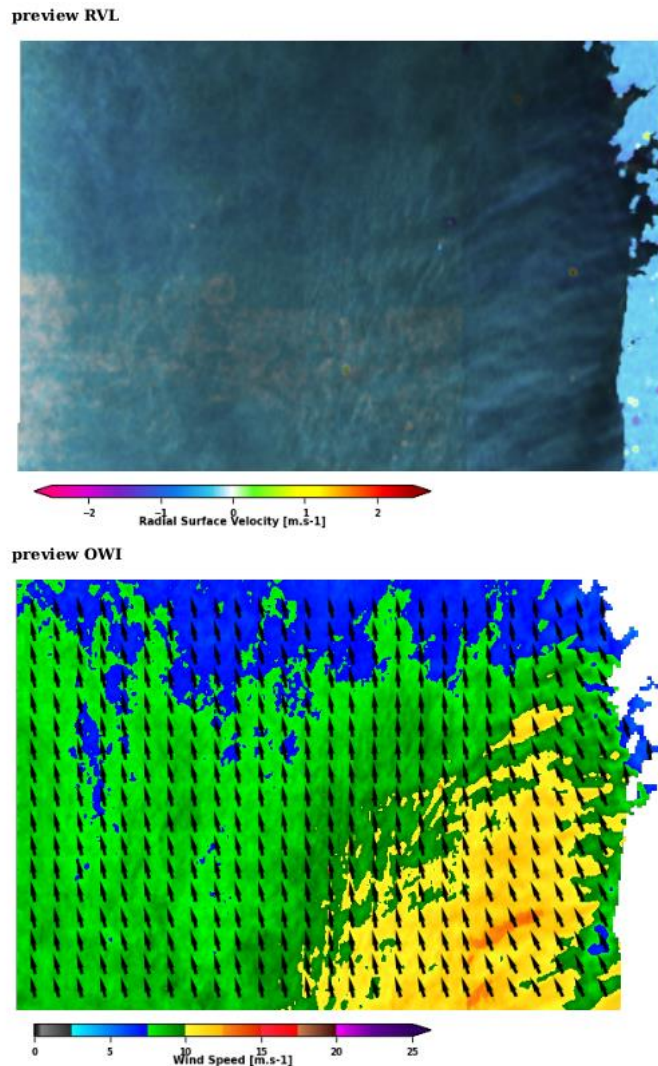

**Figure 6-13 L2 Quick-look Images (Top quick-look-l2-rvl.png with associated rvl-colorbar.png ; bottom quick-look-l2-owi.png with associated owi-colorbar.png)**

Starting with IPF 3.6.0 , L2 products contain Quick-look images relative to RVL and OWI measurements. These quick-look images are provided only for TOPS and SM products.

RVL quick-look image (quick-look-l2-rvl.png) is a low-resolution preview, as a PNG image, of the Radial Velocity provided in the L2 measurement NetCDF file. The content of this preview is a range x azimuth image of radial velocity (colored using annotated colormap) with transparency on the surface roughness (grey-level). The surface roughness is computed as the radar backscattering after compensation of the mean variations over ocean surface. The colorbar for radial velocity is attached as annotation in rvl-colorbar.png file.

OWI quick-look image (quick-look-l2-owi.png) is a low-resolution preview, as a PNG image, of the Wind Speed and Direction provided in the L2 measurement NetCDF file. The content of this preview is a range x azimuth image of owi wind speed (colored using annotated colorbar) with arrows representing the owi wind direction (with respect to the image orientation). The colorbar for wind speed is attached as annotation in owi-colorbar.png.

## 6.3 Annotation Data Sets

The sub-sections within this section contain a detailed description of each annotation data set in tabular format. The purpose of these sub-sections is to present the details of every annotation contained within the data sets in a clear layout that does not require the reader to have any knowledge of XML Schema.

### 6.3.1 L1 Product Annotation Data Set

The L1 Product ADS contains all the information pertaining to the L1 product (except for RFI detection reports and the calibration and noise vectors which are contained in separate data sets). This ADS describes attributes of the input data, the processing performed and the final output. Figure 6-14 presents a high-level graphical overview of the L1 Product ADS

The content of the L1 Product Annotation Data Set is presented in the tables below.

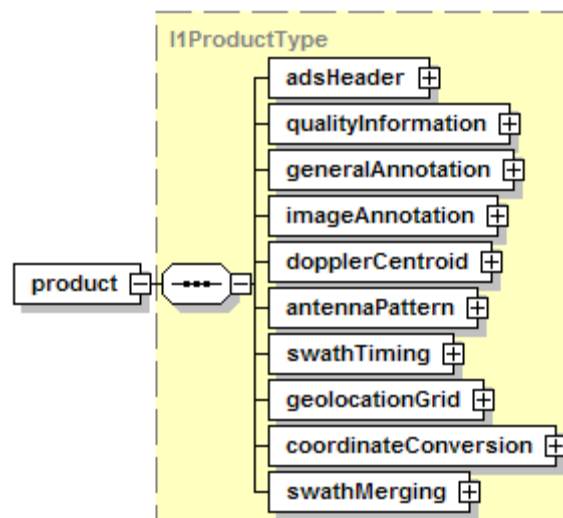

**Figure 6-14 L1 Product Annotation Data Set**



# Sentinel-1

Ref: S1-RS-MDA-52-7441  
 MPC Nom: DI-MPC-PB  
 MPC Ref: MPC-0240  
 Issue/Revision: 3/12  
 Date: 19/09/2022

**Table 6-22 Element - product**

Name	Description	Data Type	Cardinality
adsHeader	ADS header data set record. This DSR contains information that applies to the entire data set.	adsHeaderType	1
qualityInformation	Quality information data set record. This DSR contains the quality flags and the values used to set them during image processing as well as the overall quality index.	11QualityInformationType	1
generalAnnotation	General annotation data set record. This DSR contains information describing some key characteristics that apply to the entire L1 product. This includes annotations such as the sensing start and stop times, polarisation and swath. It also contains annotations derived from the input processing step including information extracted/calculated from the downlink data and raw data analysis (RDA) statistics.	11GeneralAnnotationType	1
imageAnnotation	Image annotation data set record. This DSR contains information describing the properties of the image MDS (such as data type and image dimensions) and the key parameters/options used during the processing of the image.	11ImageAnnotationType	1
dopplerCentroid	Doppler centroid data set record. This DSR contains information about the Doppler centroid values estimated and used during image processing.	11DopplerCentroidType	1
antennaPattern	Antenna pattern data set record. This DSR contains information describing the elevation antenna pattern and how it was applied by the IPF during image processing.	11AntennaPatternType	1
swathTiming	Swath timing data set record. This DSR contains the information about the bursts within the image MDS including the burst dimensions, burst timing and burst location. This DSR is specific to IW and EW SLC products.	11SwathType	1
geolocationGrid	Geolocation grid data set record. This DSR describes the geodetic position of line/pixel combinations within the image MDS.	11GeolocationGridType	1
coordinateConversion	Coordinate conversion data set record. This DSR contains the annotations required to convert between the slant range and ground range coordinate systems.	11CoordinateConversionType	1



# Sentinel-1

Ref: S1-RS-MDA-52-7441  
MPC Nom: DI-MPC-PB  
MPC Ref: MPC-0240  
Issue/Revision: 3/12  
Date: 19/09/2022

Name	Description	Data Type	Cardinality
swathMerging	Swath merging data set record. This DSR contains the annotations for interpreting the way in which IW or EW swaths were merged during GRD processing.	11SwathMergeType	1

## 6.3.1.1 Quality Information Data Set Record

Quality information data set record. This DSR contains the quality flags that are set during image processing as well as the overall quality index.

Each quality flag indicates the status of a comparison between the corresponding value from the product annotations and a pre-defined threshold. The threshold usually comes from the auxiliary processor parameters file but may also come from an internal parameter file.

The product quality index is a value that gives an overall assessment of the product quality by calculating a confidence measure based on the detailed product quality information. Currently, the product quality index is reserved for future use and the value of this field is always set to 0.0.

Figure 6-15 presents a graphical view of the structure and content of the Quality Information ADSR and the subsequent tables describe the schemas defined in Appendix A2.

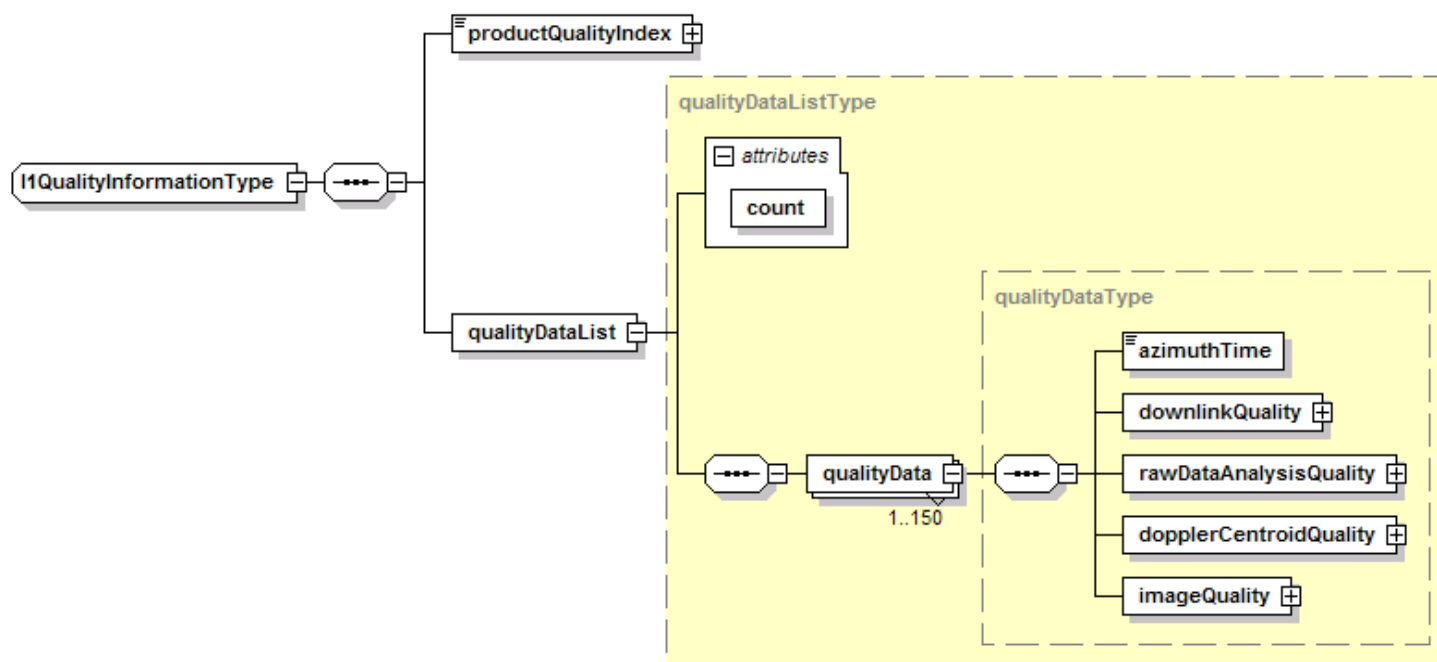

Figure 6-15 L1 Quality Information ADSR



**Table 6-23 Data Type - I1QualityInformationType**

Name	Description	Data Type	Cardinality
productQualityIndex	Overall product quality index. This annotation is calculated based on specific quality parameters and gives an overall quality value to the product. This parameter is reserved for future use and its value is set to 0.0.	double	1
qualityDataList	Quality data list. This element contains a list of qualityData records which contain the quality values and flags calculated and set during image processing. For individual scene and slice products there is one qualityData record in the list. For assembled products the list contains one qualityData record for each slice included in the assembled product.	qualityDataListType	1

**Table 6-24 Data Type - qualityDataListType**

Name	Description	Data Type	Cardinality
<i>count</i>	<i>Number of qualityData records within the list.</i>	<i>unsignedInt</i>	<i>required</i>
qualityData	Quality data. This record contains the quality values and flags that are set during image processing. Each flag indicates the status of a comparison between the corresponding value(s) and a pre-defined threshold. For individual scene and slice products there is one qualityData record. For assembled products the list contains all the qualityData records for each slice included in the assembled product. For a minimum output slice length of 10s and a maximum segment length of 25 minutes, the maximum number of records in the list is 150.	qualityDataType	1 .. 150

**Table 6-25 Data Type - qualityDataType**

Name	Description	Data Type	Cardinality
azimuthTime	Zero Doppler azimuth time at which this set of quality annotations applies [UTC].	timeType	1
downlinkQuality	Downlink quality. This record contains the quality indicators - values and flags - related to the downlink information.	downlinkQualityType	1
rawDataAnalysisQuality	Raw data analysis quality. This record contains the quality indicators - values and flags - related to the raw data analysis information.	rawDataAnalysisQualityType	1





# Sentinel-1

Ref: S1-RS-MDA-52-7441  
 MPC Nom: DI-MPC-PB  
 MPC Ref: MPC-0240  
 Issue/Revision: 3/12  
 Date: 19/09/2022

Name	Description	Data Type	Cardinality
dopplerCentroidQuality	Doppler centroid quality. This record contains the quality indicators - values and flags - related to the Doppler centroid estimation.	dopplerCentroidQualityType	1
imageQuality	Image quality. This record contains the quality indicators - values and flags - related to properties of the output image.	imageQualityType	1

**Table 6-26 Data Type - downlinkQualityType**

Name	Description	Data Type	Cardinality
iInputDataMean	Calculated mean of the input data for the I channel.	double	1
qInputDataMean	Calculated mean of the input data for the Q channel.	double	1
inputDataMeanOutsideNominalRangeFlag	Input data mean outside nominal range flag. False if the mean of I and Q input values are both within specified range from expected mean. For expected mean of x, the measured mean must fall between x-threshold to x+threshold. True otherwise.	bool	1
iInputDataStdDev	Calculated standard deviation of the input data for the I channel.	double	1
qInputDataStdDev	Calculated standard deviation of the input data for the Q channel.	double	1
inputDataStdDevOutsideNominalRangeFlag	Input data standard deviation outside nominal range flag. False if the standard deviation values of I and Q input values are both within specified range of expected standard deviation. For expected std. dev. x, the measured std. dev. must fall between x-threshold to x+threshold. True otherwise.	bool	1
numDownlinkInputDataGaps	Number of downlink gaps detected in the input data.	uint32	
downlinkGapsInInputDataSignificantFlag	Significant downlink gaps in the input data flag. A downlink input data gap is defined as a contiguous block of N downlink missing lines (the value of N is predefined for each product). False if the number of downlink input gaps is less than or equal to the threshold value, true if number of downlink input data gaps is greater than the threshold value.	bool	



# Sentinel-1

Ref: S1-RS-MDA-52-7441  
 MPC Nom: DI-MPC-PB  
 MPC Ref: MPC-0240  
 Issue/Revision: 3/12  
 Date: 19/09/2022

Name	Description	Data Type	Cardinality
numDownlinkInputMissingLines	Number of downlink missing lines detected in the input data, excluding data gaps. A downlink missing line is defined as any echo line physically absent from the input data file due to a downlink error.	uint32	
downlinkMissingLinesSignificantFlag	Downlink missing lines significant flag. False if the percentage of downlink missing lines is less than or equal to the threshold value, true if the percentage of downlink missing lines is greater than the threshold value. The number of downlink missing lines is numDownlinkInputMissingLines.	bool	
numInstrumentInputDataGaps	Number of instrument gaps detected in the input data.	uint32	1
instrumentGapsInInputDataSignificantFlag	Significant instrument gaps in the input data flag. An instrument input data gap is defined as a contiguous block of N instrument missing lines (the value of N is predefined for each product). False if the number of instrument input gaps is less than or equal to the threshold value, true if number of instrument input data gaps is greater than the threshold value.	bool	1
numInstrumentInputMissingLines	Number of instrument missing lines detected in the input data, excluding data gaps. An instrument missing line is defined as any echo line physically absent from the input data file due to a failure by the instrument to produce the expected echo line.	uint32	1
instrumentMissingLinesSignificantFlag	Instrument missing lines significant flag. False if the percentage of instrument missing lines is less than or equal to the threshold value, true if the percentage of instrument missing lines is greater than the threshold value. The number of instrument missing lines is numInstrumentInputMissingLines.	bool	1
numSsbErrorInputDataGaps	Number of gaps detected in the input data due to the SSB Error flag being set.	uint32	1
ssbErrorGapsInInputDataSignificantFlag	Significant SSB Error gaps in the input data flag. An SSB Error input data gap is defined as a contiguous block of N lines in which the SSB Error Flag is set to true (the value of N is predefined for each product). False if the number of SSB Error input gaps is less than or equal to the threshold value, true if number of SSB Error input data gaps is greater than the threshold value.	bool	1
numSsbErrorInputMissingLines	Number of SSB Error missing lines detected in the input data, excluding data gaps. An SSB Error missing line is defined as any echo line in which the SSB Error Flag is the ISP secondary header is set to true.	uint32	1
ssbErrorMissingLinesSignificantFlag	SSB Error missing lines significant flag. False if the percentage of SSB Error missing lines is less than or equal to the threshold value, true if the percentage of SSB Error missing lines is greater than the threshold value. The number of SSB Error missing lines is numSsbErrorInputMissingLines.	bool	1



# Sentinel-1

Ref: S1-RS-MDA-52-7441  
MPC Nom: DI-MPC-PB  
MPC Ref: MPC-0240  
Issue/Revision: 3/12  
Date: 19/09/2022

Name	Description	Data Type	Cardinality
chirpSourceUsed	Chirp source used during processing (Nominal or Extracted). This value is a copy of the value from the processingOptions record.	chirpSourceType	1
pgSourceUsed	PG source used during processing (Model or Extracted). This value is a copy of the value from the referenceReplica record.	pgSourceType	1
rrfSpectrumUsed	Type of range replica function used (Unextended, Extended Flat, Extended Tapered). This value is a copy of the value from the processingOptions record.	rrfSpectrumType	1
replicaReconstructionFailedFlag	Chirp replica reconstruction failed or is of low quality flag. False if able to reconstruct at least one valid extracted replica during processing. True if unable to reconstruct any valid extracted replicas during processing. A replica is valid if it was successfully reconstructed and all quality measures were acceptable. If this flag is true then the processor uses the nominal range pulse for processing and a nominal elevation beam scaling factor.	bool	1
meanPgProductAmplitude	Mean of all PG product amplitude values from the replicas extracted from the calibration pulses.	double	1
stdDevPgProductAmplitude	Standard deviation of all PG product amplitude values from the replicas extracted from the calibration pulses.	double	1
meanPgProductPhase	Mean value of all PG product phase values from the replicas extracted from the calibration pulses [radians].	double	1
stdDevPgProductPhase	Standard deviation of all PG product phase values from the replicas extracted from the calibration pulses [radians].	double	1
pgProductDerivationFailedFlag	PG product derivation failed flag. False if the percentage of invalid relative and absolute PG products is below the configured threshold; or, true otherwise. If this flag is set to true then the values from the PG product model will be used in place of the derived PG product values.	bool	1
invalidDownlinkParamsFlag	Invalid downlink parameters flag. False if all parameters read from the downlinked data were valid, true if any downlink parameter is out of range and therefore a default value has been used during processing.	bool	1



# Sentinel-1

Ref: S1-RS-MDA-52-7441  
 MPC Nom: DI-MPC-PB  
 MPC Ref: MPC-0240  
 Issue/Revision: 3/12  
 Date: 19/09/2022

**Table 6-27 Data Type - rawDataAnalysisQualityType**

Name	Description	Data Type	Cardinality
iBias	Calculated I bias. This value is a copy of the value from the rawDataAnalysis record.	double	1
iBiasSignificanceFlag	I bias significance, true if I bias falls within acceptable range, false otherwise.	bool	1
qBias	Calculated Q bias. This value is a copy of the value from the rawDataAnalysis record.	double	1
qBiasSignificanceFlag	Q bias significance, true if Q bias falls within acceptable range, false otherwise.	bool	1
iqGainImbalance	Calculated I/Q gain imbalance. This value is a copy of the value from the rawDataAnalysis record.	double	1
iqGainSignificanceFlag	I/Q Gain Significance, true if I/Q gain imbalance falls within acceptable range, false otherwise.	bool	1
iqQuadratureDeparture	Calculated I/Q quadrature departure.	double	1
iqQuadratureDepartureSignificanceFlag	I/Q Quadrature Departure Significance, true if quadrature departure falls within acceptable range, false otherwise.	bool	1

**Table 6-28 Data Type - dopplerCentroidQualityType**

Name	Description	Data Type	Cardinality
dcMethod	Doppler centroid estimation method used during processing. Both the Doppler centroid (DC) calculated from orbit geometry and the DC estimated from the raw data are annotated within the Doppler data set; however, this parameter describes the actual DC method used during image processing. This value is a copy of the value from the processingOptions record.	dcMethodType	1
dopplerCentroidUncertainFlag	Doppler centroid uncertain flag. False if the root mean squared (RMS) error for the DCE method used for image processing is less than the specified threshold, true if the RMS error is greater than or equal to the specified threshold. Note: if more than one Doppler centroid estimation is performed, the flag is set to true if any RMS error is greater than or equal to the threshold).	bool	1

**Table 6-29 Data Type - imageQualityType**

Name	Description	Data Type	Cardinality
imageStatistics	Mean and standard deviation statistics for the image. This record is a copy of the record from the imageInformation record.	imageStatisticsType	1
outputDataMeanOutsideNominalRangeFlag	Output data mean outside nominal range flag. False if the mean of I and Q output values for SLC image or mean of detected pixels for a detected product, are both within specified range from expected mean. For expected mean of x, the measured mean must fall between x-threshold to x+threshold. True otherwise.	bool	1
outputDataStDevOutsideNominalRangeFlag	Output data standard deviation outside nominal range flag. False if the std. dev. of I and Q output values for SLC image or std. dev. of detected pixels for a detected product, are both within specified range from expected std. dev. For expected std. dev. of x, the measured std. dev. must fall between x-threshold to x+threshold. True otherwise.	bool	1

**Table 6-30 Data Type - imageStatisticsType**

Name	Description	Data Type	Cardinality
outputDataMean	Mean value of output data.	complex	1
outputDataStdDev	Standard deviation of output data.	complex	1

## 6.3.1.2 General Annotation Data Set Record

General annotation data set record. This DSR contains information describing some key characteristics that apply to the entire L1 product. This includes annotations such as the sensing start and stop times, polarisation and swath. It also contains annotations derived from the input processing step including information extracted/calculated from the downlink data and raw data analysis statistics.

Figure 6-16 presents a graphical view of the structure and content of the General ADSR and the subsequent tables describe the schemas defined in Appendix A2.

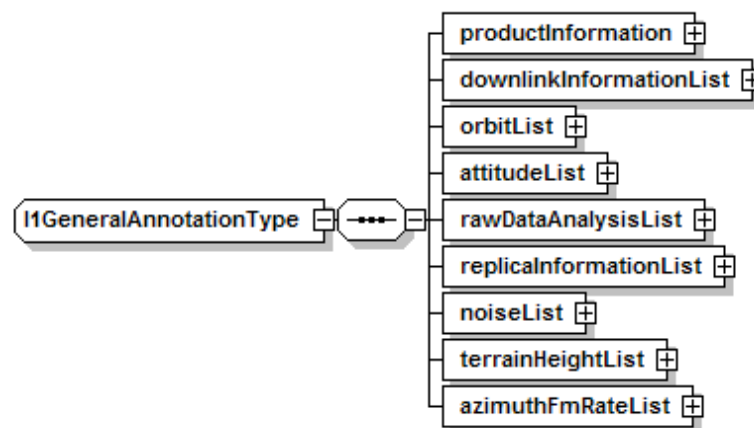

Figure 6-16 L1 General ADSR

Table 6-31 Data Type - I1GeneralAnnotationType

Name	Description	Data Type	Cardinality
productInformation	General product information. This record describes some key characteristics of the product, the input data and the acquisition platform.	productInformationType	1



# Sentinel-1

Ref: S1-RS-MDA-52-7441  
MPC Nom: DI-MPC-PB  
MPC Ref: MPC-0240  
Issue/Revision: 3/12  
Date: 19/09/2022

Name	Description	Data Type	Cardinality
downlinkInformationList	Downlink information list. This element contains a list of downlinkInformation records which contain information extracted and calculated from the input data.	downlinkInformationListType	1
orbitList	List of orbit information used by the IPF during processing. This list contains sets of orbit state vectors that are updated along azimuth. The values represent the interpolated values used by the IPF and are derived from the sub-commutated ancillary data from the ISPs or from an input auxiliary orbit file.	orbitListType	1
attitudeList	List of attitude information used by the IPF during processing. This list contains sets of attitude data records that are updated along azimuth. The values represent the interpolated values used by the IPF and are derived from the sub-commutated ancillary data from the ISPs or from an input auxiliary attitude file.	attitudeListType	1
rawDataAnalysisList	Raw data analysis list. This element contains a list of rawDataAnalysis records which contain statistics collected from the input data.	rawDataAnalysisListType	1
replicaInformationList	Replica information list. This element contains a list of replicaInformation records, which describe the reference replica and the reconstructed replicas created from the calibration pulses extracted from the downlink.	replicaInformationListType	1
noiseList	Noise list. This element is a list of noise records that contain the noise parameters derived from the noise ISPs. The list contains an entry for each noise update made along azimuth. If the noise list is empty, the nominal noise value in the instrument auxiliary data file will be used instead.	noiseListType	1
terrainHeightList	Terrain height list. This element is a list of terrainHeight records that contain the average terrain height at the given zero Doppler azimuth time. The actual terrain heights used by the IPF may represent bilinearly interpolated values from this list. The list contains an entry for each terrain height update made along azimuth.	terrainHeightListType	1
azimuthFmRateList	Azimuth Frequency Modulation (FM) rate list. This element is a list of azimuthFmRate records that contain the parameters needed to calculate the azimuth FM rate. The list contains an entry for each azimuth FM rate update made along azimuth.	azimuthFmRateListType	1



**Table 6-32 Data Type - productInformationType**

Name	Description	Data Type	Cardinality
pass	Direction of the orbit (ascending, descending) for the oldest image data in the product (the start of the product).	passDirectionType	1
timelinessCategory	Timeliness category under which the product was produced, i.e. time frame from the data acquisition (for the near real time categories) or from the satellite tasking to the product delivery to the end user.	string	1
platformHeading	Platform heading relative to North [degrees].	double	1
projection	Projection of the image, either slant range or ground range.	projectionType	1
rangeSamplingRate	Range sample rate [Hz].	double	1
radarFrequency	Radar frequency [Hz].	double	1
azimuthSteeringRate	Azimuth steering rate for IW and EW modes [degrees/s].	double	1

**Table 6-33 Data Type - downlinkInformationListType**

Name	Description	Data Type	Cardinality
<i>count</i>	<i>Number of downlink information records within the list.</i>	<i>unsignedInt</i>	<i>required</i>
downlinkInformation	Downlink information. This record contains information about the data extracted/calculated from the input data, including values extracted from the ISP and data error counters. For individual scene and slice products there is one downlinkInformation record, except in the case of IW/EW GRD products, where there will be one record per swath. For assembled products the list contains all the downlinkInformation records for each slice included in the assembled product. For a minimum output slice length of 10s, a maximum segment length of 25 minutes and a maximum 5 swaths, the maximum number of records in the list is 750.	downlinkInformationType	1 .. 750





**Table 6-34 Data Type - downlinkInformationType**

Name	Description	Data Type	Cardinality
swath	Swath from which this downlink information data was extracted.	swathType	1
azimuthTime	Zero Doppler azimuth time at which this set of downlink information applies [UTC].	timeType	1
firstLineSensingTime	Sensing time of first line of input data [UTC].	timeType	1
lastLineSensingTime	Sensing time of last line of input data [UTC].	timeType	1
prf	Pulse repetition frequency (PRF) of the input raw data [Hz]. This is the inverse of the PRI extracted from the downlink for this swath.	double	1
bitErrorCount	Error counters. This record contains the error counter for each field that is validated as the input source packets are analyzed.	bitErrorCountType	1
downlinkValues	Downlink values. This record contains values extracted directly from the Instrument Source Packets.	downlinkValuesType	1

**Table 6-35 Data Type - bitErrorCountType**

Name	Description	Data Type	Cardinality
numErrSyncMarker	Number of errors detected in the sync marker field.	uint32	1
numErrDataTakeId	Number of errors detected in the data take identifier field.	uint32	1
numErrEccNumber	Number of errors detected in the Event Control Code (ECC) number field.	uint32	1
numErrTestMode	Number of errors detected in the test mode field.	uint32	1
numErrRxChannelId	Number of errors detected in the Rx channel identifier field.	uint32	1
numErrInstrumentConfigId	Number of errors detected in the instrument configuration identifier field.	uint32	1
numErrPacketCount	Number of errors detected in the space packet count field.	uint32	1
numErrPriCount	Number of errors detected in the Pulse Repetition Interval (PRI) count field.	uint32	1



# Sentinel-1

Ref: S1-RS-MDA-52-7441  
MPC Nom: DI-MPC-PB  
MPC Ref: MPC-0240  
Issue/Revision: 3/12  
Date: 19/09/2022

Name	Description	Data Type	Cardinality
numErrSsbErrorFlag	Number of packets in which the SSB Error Flag is set to true.	uint32	1
numErrBaqMode	Number of errors detected in the Block Adaptive Quantisation (BAQ) mode field.	uint32	1
numErrBaqBlockLength	Number of errors detected in the BAQ block length field.	uint32	1
numErrRangeDecimation	Number of errors detected in the range decimation field.	uint32	1
numErrRxGain	Number of errors detected in the Rx gain field.	uint32	1
numErrTxRampRate	Number of errors detected in the Tx ramp rate field.	uint32	1
numErrTxPulseStartFrequency	Number of errors detected in the Tx pulse start frequency field.	uint32	1
numErrRank	Number of errors detected in the rank field.	uint32	1
numErrPri	Number of errors detected in the PRI code field	uint32	1
numErrSwst	Number of errors detected in the sampling window start time (SWST) field.	uint32	1
numErrSwl	Number of errors detected in the sampling window length (SWL) field.	uint32	1
numErrPolarisation	Number of errors detected in the polarisation field.	uint32	1
numErrTempComp	Number of errors detected in the temperature compensation field.	uint32	1
numErrElevationBeamAddress	Number of errors detected in the elevation beam address field.	uint32	1
numErrAzimuthBeamAddress	Number of errors detected in the azimuth beam address field.	uint32	1
numErrSasTestMode	Number of errors detected in the SAR Antenna Sub-system (SAS) test mode field.	uint32	1
numErrCalType	Number of errors detected in the calibration operation type field.	uint32	1
numErrCalibrationBeamAddress	Number of errors detected in the calibration beam address field.	uint32	1
numErrCalMode	Number of errors detected in the calibration mode field.	uint32	1
numErrTxPulseNumber	Number of errors detected in the Tx pulse number field.	uint32	1



# Sentinel-1

Ref: S1-RS-MDA-52-7441  
 MPC Nom: DI-MPC-PB  
 MPC Ref: MPC-0240  
 Issue/Revision: 3/12  
 Date: 19/09/2022

Name	Description	Data Type	Cardinality
numErrSignalType	Number of errors detected in the signal type field.	uint32	1
numErrSwapFlag	Number of errors detected in the swap flag field.	uint32	1
numErrSwathNumber	Number of errors detected in the swath number field.	uint32	1
numErrNumberOfQuads	Number of errors detected in the number of quads field.	uint32	1
numIspHeaderErrors	Total number of errors detected in ISP headers.	uint32	1

**Table 6-36 Data Type - downlinkValuesType**

Name	Description	Data Type	Cardinality
pri	Pulse Repetition Interval [s].	double	1
rank	The number of PRI between transmitted pulse and return echo.	uint16	1
dataTakeId	Data take identifier.	uint16	1
eccNumber	The ECC number of the measurement mode.	uint16	1
rxChannelId	Receive channel identifier.	uint16	1
instrumentConfigId	Instrument configuration identifier.	uint32	1
dataFormat	Data format for instrument samples. There is one element corresponding to the data format for each packet type in the segment.	dataFormatType	1
rangeDecimation	Decimation of the SAR data in the sampling window according to the needed mode bandwidth.	rangeDecimationType	1
rxGain	Applied value of the commandable Rx attenuation in the receiver channel of the SES.	double	1
txPulseLength	Transmit pulse length [s].	double	1
txPulseStartFrequency	Starting frequency of the transmit pulse [Hz].	double	1
txPulseRampRate	The linear FM rate at which the frequency changes over the pulse duration [Hz/s].	double	1



# Sentinel-1

Ref: S1-RS-MDA-52-7441  
 MPC Nom: DI-MPC-PB  
 MPC Ref: MPC-0240  
 Issue/Revision: 3/12  
 Date: 19/09/2022

Name	Description	Data Type	Cardinality
swathNumber	SPPDU swath number identifier.	swathNumberType	1
swlList	List of sampling window lengths.	swlListType	1
swstList	List of sampling window start time changes.	swstListType	1
pointingStatusList	List of pointing status changes.	pointingStatusListType	1

**Table 6-37 Data Type - dataFormatType**

Name	Description	Data Type	Cardinality
baqBlockLength	BAQ block length for all packets.	ubyte	1
echoFormat	Data format of echo packets.	dataFormatModeType	1
noiseFormat	Data format of noise packets.	dataFormatModeType	1
calibrationFormat	Data format of calibration packets.	dataFormatModeType	1
meanBitRate	The calculated mean FDBAQ bit rate code for echo packets over the entire segment. This field applies only when the echoFormat is FDBAQ.	double	1

**Table 6-38 Data Type - rangeDecimationType**

Name	Description	Data Type	Cardinality
decimationFilterBandwidth	Filter bandwidth used to decimate the SAR signal data [Hz].	double	1
samplingFrequencyAfterDecimation	Sampling frequency of the SAR signal data after decimation [Hz]. This frequency is equivalent to the to the sampling frequency before decimation multiplied by the decimation ratio.	double	1
filterLength	Length of the decimation filter [samples]	uint32	1



# Sentinel-1

Ref: S1-RS-MDA-52-7441  
MPC Nom: DI-MPC-PB  
MPC Ref: MPC-0240  
Issue/Revision: 3/12  
Date: 19/09/2022

**Table 6-39 Data Type - swlListType**

Name	Description	Data Type	Cardinality
<i>count</i>	<i>Number of SWL records within the list.</i>	<i>unsignedInt</i>	<i>required</i>
swl	Sampling window length record. This record holds the SWL for the given zero Doppler azimuth time. For a SWL update rate of approximately 8s and a maximum segment length of 25 minutes, the maximum number of records in the list is 200.	swstType	1 .. 200

**Table 6-40 Data Type - swlType**

Name	Description	Data Type	Cardinality
azimuthTime	Zero Doppler azimuth time of sampling window length change [UTC].	timeType	1
value	Sampling Window Length [s].	double	1

**Table 6-41 Data Type - swstListType**

Name	Description	Data Type	Cardinality
<i>count</i>	<i>Number of swst records within the list.</i>	<i>unsignedInt</i>	<i>required</i>
swst	SWST record. This record holds the SWST for the given zero Doppler azimuth time. For a SWST update rate of approximately 8s and a maximum segment length of 25 minutes, the maximum number of records in the list is 200.	swstType	1 .. 200

**Table 6-42 Data Type - swstType**

Name	Description	Data Type	Cardinality
azimuthTime	Zero Doppler azimuth time of sampling window start change [UTC].	timeType	1



# Sentinel-1

Ref: S1-RS-MDA-52-7441  
 MPC Nom: DI-MPC-PB  
 MPC Ref: MPC-0240  
 Issue/Revision: 3/12  
 Date: 19/09/2022

Name	Description	Data Type	Cardinality
value	Sampling window start time for first range sample [s].	double	1

**Table 6-43 Data Type - pointingStatusListType**

Name	Description	Data Type	Cardinality
<i>count</i>	<i>Number of pointing status records within the list.</i>	<i>unsignedInt</i>	<i>required</i>
pointingStatus	Pointing status record. This record holds the pointing status for the given zero Doppler azimuth time. With a minimum orbit/attitude update rate of 1s and a maximum product length of 25 minutes, the maximum size of this list is 1500 elements.	pointingStatusType	1 .. 1500

**Table 6-44 Data Type - pointingStatusType**

Name	Description	Data Type	Cardinality
azimuthTime	Zero Doppler azimuth time of the pointing status change [UTC].	timeType	1
aocsOpMode	AOCS operational mode.	aocsOpModeType	1
rollErrorFlag	Roll error status. Set to false when the roll axis is fine pointed and set to true when the roll axis is degraded.	bool	1
pitchErrorFlag	Pitch error status. Set to false when the pitch axis is fine pointed and set to true when the pitch axis is degraded.	bool	1
yawErrorFlag	Yaw error status. Set to false when the yaw axis is fine pointed and set to true when the yaw axis is degraded.	bool	1



# Sentinel-1

Ref: S1-RS-MDA-52-7441  
 MPC Nom: DI-MPC-PB  
 MPC Ref: MPC-0240  
 Issue/Revision: 3/12  
 Date: 19/09/2022

**Table 6-45 Data Type - orbitListType**

Name	Description	Data Type	Cardinality
<i>count</i>	<i>Length of the orbit vector list.</i>	<i>unsignedInt</i>	<i>required</i>
orbit	Orbit state vector record. This record contains a position vector and a velocity vector which together describe the orbit state of the platform at the annotated time. With a minimum orbit/attitude update rate of 1s and a maximum product length of 25 minutes, the maximum size of this list is 1500 elements.	orbitType	1 .. 1500

**Table 6-46 Data Type - orbitType**

Name	Description	Data Type	Cardinality
time	Timestamp at which orbit state vectors apply [UTC].	timeType	1
frame	Reference frame of the orbit state data.	referenceFrameType	1
position	Position vector record. This record contains the platform position data with respect to the Earth-fixed reference frame.  Note: The Earth fixed reference frame in use is the IERS Terrestrial Reference Frame (ITRF). The zero longitude or IERS Reference Meridian (IRM), as well as the IERS Reference Pole (IRP), are maintained by the International Earth Rotation Service (IERS), based on a large number of observing stations, and define the IERS Terrestrial Reference Frame (ITRF). More details can be found in Earth Observation Mission CFI Software documentation or at <a href="https://en.wikipedia.org/wiki/ECEF">https://en.wikipedia.org/wiki/ECEF</a> .	positionType	1
velocity	Velocity vector record. This record contains the platform velocity data with respect to the Earth-fixed reference frame.	velocityType	1



# Sentinel-1

Ref: S1-RS-MDA-52-7441  
MPC Nom: DI-MPC-PB  
MPC Ref: MPC-0240  
Issue/Revision: 3/12  
Date: 19/09/2022

**Table 6-47 Data Type - positionType**

Name	Description	Data Type	Cardinality
x	X component of position vector [m].	double	1
y	Y component of position vector [m].	double	1
z	Z component of position vector [m].	double	1

**Table 6-48 Data Type - velocityType**

Name	Description	Data Type	Cardinality
x	X component of velocity vector [m/s].	double	1
y	Y component of velocity vector [m/s].	double	1
z	Z component of velocity vector [m/s].	double	1

**Table 6-49 Data Type - attitudeListType**

Name	Description	Data Type	Cardinality
<i>count</i>	<i>Length of the attitude list.</i>	<i>unsignedInt</i>	<i>required</i>
attitude	Attitude data record. This record contains the attitude quaternions and an angular velocity vector which together describe the attitude state of the platform at the annotated time. With a minimum orbit/attitude update rate of 1s and a maximum product length of 25 minutes, the maximum size of this list is 1500 elements.	attitudeType	1 .. 1500





# Sentinel-1

Ref: S1-RS-MDA-52-7441  
MPC Nom: DI-MPC-PB  
MPC Ref: MPC-0240  
Issue/Revision: 3/12  
Date: 19/09/2022

**Table 6-50 Data Type - attitudeType**

Name	Description	Data Type	Cardinality
time	Timestamp to which attitude data applies [UTC].	timeType	1
frame	Reference frame of the attitude data.	referenceFrameType	1
q0	Q0 attitude quaternion as extracted from ancillary attitude data.	float	1
q1	Q1 attitude quaternion as extracted from ancillary attitude data.	float	1
q2	Q2 attitude quaternion as extracted from ancillary attitude data.	float	1
q3	Q3 attitude quaternion as extracted from ancillary attitude data.	float	1
wx	X component of angular velocity vector as extracted from ancillary attitude data [degrees/s].	double	1
wy	Y component of angular velocity vector as extracted from ancillary attitude data [degrees/s].	double	1
wz	Z component of angular velocity vector as extracted from ancillary attitude data [degrees/s].	double	1
roll	Platform roll calculated from ancillary attitude data [degrees].	double	1
pitch	Platform pitch calculated from ancillary attitude data [degrees].	double	1
yaw	Platform yaw calculated from ancillary attitude data [degrees].	double	1



**Table 6-51 Data Type - rawDataAnalysisListType**

Name	Description	Data Type	Cardinality
<i>count</i>	<i>Number of rawDataAnalysis records within the list.</i>	<i>unsignedInt</i>	<i>required</i>
rawDataAnalysis	Raw data analysis information. This record contains data statistics collected from sampling a subset of the raw input data. It contains the values calculated for both the I and Q channels. For individual scene and slice products there is one rawDataAnalysis record except in the case of IW/EW GRD products, where there will be one record per swath. For assembled products the list contains all the downlinkInformation records for each slice included in the assembled product. For a minimum output slice length of 10s, a maximum segment length of 25 minutes and a maximum 5 swaths, the maximum number of records in the list is 750.	rawDataAnalysisType	1 .. 750

**Table 6-52 Data Type - rawDataAnalysisType**

Name	Description	Data Type	Cardinality
azimuthTime	Zero Doppler azimuth time at which this set of raw data analysis values apply [UTC].	timeType	1
iBias	Calculated I bias.	double	1
qBias	Calculated Q bias.	double	1
iqQuadratureDeparture	Calculated I/Q quadrature departure.	double	1
iqGainImbalance	Calculated I/Q gain imbalance.	double	1
support	Supporting Raw Data Analysis (RDA) values.	rawDataAnalysisSupportType	1



**Table 6-53 Data Type - rawDataAnalysisSupportType**

Name	Description	Data Type	Cardinality
iBiasUpperBound	I bias upper bound.	double	1
iBiasLowerBound	I bias lower bound.	double	1
qBiasUpperBound	Q bias upper bound.	double	1
qBiasLowerBound	Q bias lower bound.	double	1
iqGainUpperBound	I/Q gain upper bound.	double	1
iqGainLowerBound	I/Q gain lower bound.	double	1
iqQuadratureDepartureUpperBound	I/Q quadrature departure upper bound.	double	1
iqQuadratureDepartureLowerBound	I/Q quadrature departure lower bound.	double	1
iBiasUsedForCorrection	I channel bias used for correction (may be different from the calculated bias).	double	1
qBiasUsedForCorrection	Q channel bias used for correction (may be different from the calculated bias).	double	1
iqGainImbalanceUsedForCorrection	I/Q gain imbalance used for correction (may be different from the calculated gain).	double	1
iqQuadratureDepartureUsedForCorrection	I/Q quadrature departure used for correction (may be different from the calculated quadrature departure).	double	1

**Table 6-54 Data Type - replicaInformationListType**

Name	Description	Data Type	Cardinality
<i>count</i>	<i>Number of replicaInformation records within the list.</i>	<i>unsignedInt</i>	<i>required</i>



# Sentinel-1

Ref: S1-RS-MDA-52-7441  
 MPC Nom: DI-MPC-PB  
 MPC Ref: MPC-0240  
 Issue/Revision: 3/12  
 Date: 19/09/2022

Name	Description	Data Type	Cardinality
replicaInformation	Replica information. This record contains information about the reference and reconstructed replicas. There will be one replica information record per ADS, except for IW/EW GRD products which will contain one per swath.	replicaInformationType	1 .. 5

**Table 6-55 Data Type - replicaInformationType**

Name	Description	Data Type	Cardinality
swath	Swath to which this replica information applies.	swathType	1
referenceReplica	Reference replica record. This record contains information about the reference imaging replica that was used by the IPF during processing. When the extracted replica is used for processing the information in this record comes from the calibration pulses at the nominal imaging bandwidth. When the nominal replica is used for processing the information in this record comes directly from the AUX_INS data.	referenceReplicaType	1
replicaList	Replica list. This element contains a list of the reconstructed replicas created from the PG calibration pulses at 100 MHz bandwidth extracted from the downlink. The list contains an entry for each complete calibration sequence.	replicaListType	1

**Table 6-56 Data Type – referenceReplicaType**

Name	Description	Data Type	Cardinality
azimuthTime	Zero Doppler azimuth time of the middle of the calibration sequence that the reference replica was created from [UTC].	timeType	1
chirpSource	Source of the reference replica: Nominal or Extracted.	chirpSourceType	1
pgSource	Source of the PG values used in processing: Model or Extracted.	pgSourceType	1



# Sentinel-1

Ref: S1-RS-MDA-52-7441  
 MPC Nom: DI-MPC-PB  
 MPC Ref: MPC-0240  
 Issue/Revision: 3/12  
 Date: 19/09/2022

Name	Description	Data Type	Cardinality
amplitudeCoefficients	Reference replica amplitude coefficients. This element contains the count attribute number of single precision floating point values separated by spaces.	floatCoefficientArray	1
phaseCoefficients	Reference replica phase coefficients. This element contains the count attribute number of single precision floating point values separated by spaces.	floatCoefficientArray	1
timeDelay	Internal time delay [s] representing the average deviation of the replica location from the location of the transmitted pulse. If the pgSource is Model, then this value is filled with the timeDelay parameter from the AUX_INS file. If the pgSource is Extracted, then this value is filled with the average internal time delay calculated across all valid extracted PG replicas reconstructed from the calibration pulses at 100 MHz bandwidth.	float	1
gain	Complex gain to be applied to the range match filter to compensate for the amplitude and phase differences between the two channels in dual polarisation data.	complex	1

**Table 6-57 Data Type - replicaListType**

Name	Description	Data Type	Cardinality
<i>count</i>	<i>Number of replica records within the list.</i>	<i>unsignedInt</i>	<i>required</i>
replica	PG chirp replica parameters derived from the calibration pulses at 100 MHz bandwidth, With an average calibration cycle interval of 5s and a maximum product length of 25 minutes, the maximum size of this list is 300 elements.	replicaType	0 .. 300



# Sentinel-1

Ref: S1-RS-MDA-52-7441  
 MPC Nom: DI-MPC-PB  
 MPC Ref: MPC-0240  
 Issue/Revision: 3/12  
 Date: 19/09/2022

**Table 6-58 Data Type - replicaType**

Name	Description	Data Type	Cardinality
azimuthTime	Zero Doppler azimuth time in azimuth at which replica applies [UTC].	timeType	1
crossCorrelationBandwidth	3-dB pulse width of cross-correlation function between the reconstructed replica and the nominal replica [samples].	float	1
crossCorrelationPslr	Peak side lobe level (PSLR) of cross-correlation function between the reconstructed replica and the nominal replica [dB].	float	1
crossCorrelationIslr	Integrated Side Lobe Ratio (ISLR) of cross-correlation function between the reconstructed replica and the nominal replica [dB].	float	1
crossCorrelationPeakLocation	Peak location of cross-correlation function between the reconstructed replica and the nominal replica [samples].	float	1
reconstructedReplicaValidFlag	Indicates if the cross-correlation between the nominal PG replica and this extracted PG replica resulted in a valid peak location. Set to true if a valid peak location was found; or, false otherwise.	bool	1
pgProductAmplitude	<p>Amplitude of the PG product derived from this replica. The amplitude value annotated for the PG product is:</p> $abs(1/PG \cdot sqrt(meanRxCalPow(swath_1)/meanRxCalPow(swath_n)))$ <p>Where:</p> <ul style="list-style-type: none"> <li><i>abs()</i> is the absolute value function for a complex number;</li> <li><i>sqrt()</i> is the square root function;</li> <li><i>meanRxCalPow(swath<sub>1</sub>)</i> is the mean RX calibration power of swath 1 calculated according to [R-14];</li> <li><i>meanRxCalPow(swath<sub>n</sub>)</i> is the mean RX calibration power of the current swath calculated according to [R-14].</li> </ul> <p>PG product values can only be calculated for products that have at least one valid extracted reconstructed replica. If no valid extracted reconstructed replica exists within the product then this value will be set to the default value of 1.0 for every replica record.</p>	float	1
pgProductPhase	Phase of the PG product derived from this replica [radians]. The phase value annotated for the PG product is:	float	1



# Sentinel-1

Ref: S1-RS-MDA-52-7441  
 MPC Nom: DI-MPC-PB  
 MPC Ref: MPC-0240  
 Issue/Revision: 3/12  
 Date: 19/09/2022

Name	Description	Data Type	Cardinality
	$\arg(1/PG \cdot \sqrt{\text{meanRxCalPow}(\text{swath}_1)/\text{meanRxCalPow}(\text{swath}_n)})$ <p>Where:</p> <ul style="list-style-type: none"> <li>• <math>\arg()</math> is the phase value function for a complex number;</li> <li>• <math>\sqrt{}</math> is the square root function;</li> <li>• <math>\text{meanRxCalPow}(\text{swath}_1)</math> is the mean RX calibration power of swath 1 calculated according to [R-14];</li> <li>• <math>\text{meanRxCalPow}(\text{swath}_n)</math> is the mean RX calibration power of the current swath calculated according to [R-14].</li> </ul> <p>PG product values can only be calculated for products that have at least one valid extracted reconstructed replica. If no valid extracted reconstructed replica exists within the product then this value will be set to the default value of 0.0 for every replica record.</p>		
modelPgProductAmplitude	PG product amplitude value from the input PG product model.	float	1
modelPgProductPhase	PG product phase value from the input PG product model [radians].	float	1
relativePgProductValidFlag	<p>Indicates if the amplitude and phase of the PG product passed relative validation. Set to true if <math> \text{pgProductAmplitude} - \text{meanPgProductAmplitude}  &lt; \text{pgAmpStdFractionThreshold} * \text{stdDevPgProductAmplitude}</math> and <math> \text{pgProductPhase} - \text{meanPgProductPhase}  &lt; \text{pgPhaseStdFractionThreshold} * \text{stdDevPgProductPhase}</math>; or, false otherwise.</p> <p>Where <math>\text{pgAmpStdFractionThreshold}</math> and <math>\text{pgPhaseStdFractionThreshold}</math> are configured threshold values.</p> <p>PG product values can only be calculated and validated for products that have at least one valid extracted reconstructed replica. If no valid extracted reconstructed replica exists within the product then this flag will be set to false for every replica record.</p>	bool	1
absolutePgProductValidFlag	<p>Indicates if the amplitude and phase of the PG product passed the absolute validation. Set to true if <math> \text{pgProductAmplitude} - \text{modelPgProductAmplitude}  &lt; \text{maxPgAmpErrorThreshold}</math> and <math> \text{pgProductPhase} - \text{modelPgProductPhase}  &lt; \text{maxPgPhaseErrorThreshold}</math>; or, false otherwise.</p> <p>Where <math>\text{maxPgAmpErrorThreshold}</math> and <math>\text{maxPgPhaseErrorThreshold}</math> are configured threshold values and <math>\text{modelPgProductAmplitude}</math> and <math>\text{modelPgProductPhase}</math> are values obtained from the PG product model.</p>	bool	1



# Sentinel-1

Ref: S1-RS-MDA-52-7441  
 MPC Nom: DI-MPC-PB  
 MPC Ref: MPC-0240  
 Issue/Revision: 3/12  
 Date: 19/09/2022

Name	Description	Data Type	Cardinality
	PG product values can only be calculated and validated for products that have at least one valid extracted reconstructed replica. If no valid extracted reconstructed replica exists within the product then this flag will be set to false for every replica record.		
internalTimeDelay	Internal time delay [s] representing the calculated deviation of the location of this PG replica from the location of the transmitted pulse; i.e., the nominal PG replica.	float	1

**Table 6-59 Data Type - noiseListType**

Name	Description	Data Type	Cardinality
<i>count</i>	<i>Number of noise records within the list.</i>	<i>unsignedInt</i>	<i>required</i>
noise	Noise parameters derived from noise packets. There is a maximum of two sets of noise parameters per swath.	noiseType	0 .. 1500

**Table 6-60 Data Type - noiseType**

Name	Description	Data Type	Cardinality
swath	Swath to which the noise information applies.	swathType	1
azimuthTime	Zero Doppler azimuth time of the noise measurement [UTC].	timeType	1
noisePowerCorrectionFactor	Noise power correction factor.	float	1
numberOfNoiseLines	Number of noise lines used to calculate noise correction factor.	uint32	1





**Table 6-61 Data Type - terrainHeightListType**

Name	Description	Data Type	Cardinality
<i>count</i>	<i>Number of terrain height records within the list.</i>	<i>unsignedInt</i>	<i>Required</i>
terrainHeight	Terrain height record containing the average terrain height (in metres above the ocean surface) for the given zero Doppler azimuth time. With a minimum terrain height spacing of 1s and a maximum product length of 25 minutes, the maximum size of this list is 1500 elements.	terrainHeightType	1 .. 1500

**Table 6-62 Data Type - terrainHeightType**

Name	Description	Data Type	Cardinality
azimuthTime	Zero Doppler azimuth time of terrain height measurement [UTC].	timeType	1
value	Average terrain height above ocean surface [m]. The value is the average height in the range direction for the given zero Doppler azimuth time.	double	1

**Table 6-63 Data Type - azimuthFmRateListType**

Name	Description	Data Type	Cardinality
<i>count</i>	<i>Number of azimuthFmRate records within the list.</i>	<i>unsignedInt</i>	<i>required</i>
azimuthFmRate	Azimuth FM rate = $c0 + c1(tSR - t0) + c2(tSR - t0)^2$ . Where tSR = two way slant range time. With a minimum azimuth processing block length of approximately 2s and a maximum product length of 25 minutes, the maximum size of this list is 750 elements.	azimuthFmRateType	1 .. 750



# Sentinel-1

Ref: S1-RS-MDA-52-7441  
MPC Nom: DI-MPC-PB  
MPC Ref: MPC-0240  
Issue/Revision: 3/12  
Date: 19/09/2022

**Table 6-64 Data Type - azimuthFmRateType**

Name	Description	Data Type	Cardinality
azimuthTime	Zero Doppler azimuth time to which azimuth FM rate parameters apply [UTC].	timeType	1
t0	Two way slant range time origin used for azimuth FM rate calculation [s].	double	1
azimuthFmRatePolynomial	Azimuth FM rate coefficients array in order of c0 [Hz/s] c1 [Hz/s^2] c2 [Hz/s^3].	doubleCoefficientArray	1

### 6.3.1.3 Image Annotation Data Set Record

Image annotation data set record. This DSR contains information describing the properties of the image MDS (such as data type and image dimensions) and the key parameters/options used during the processing of the image.

Figure 6-17 presents a graphical view of the structure and content of the image ADSR and the subsequent tables describe the schemas defined in Appendix A2.

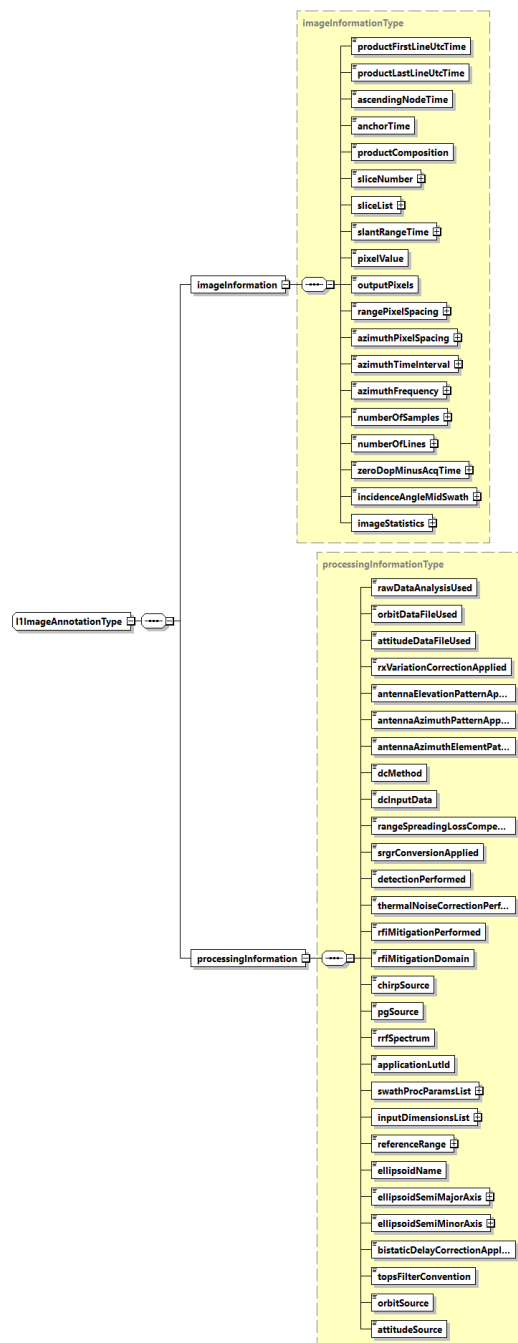

Figure 6-17 L1 Image ADSR



**Table 6-65 Data Type - I1ImageAnnotationType**

Name	Description	Data Type	Cardinality
imageInformation	Image information. This record contains the elements that describe the properties and characteristics of the image MDS.	imageInformationType	1
processingInformation	Processing information. This record contains information describing the key options and parameters used by the IPF during image processing.	processingInformationType	1

**Table 6-66 Data Type - imageInformationType**

Name	Description	Data Type	Cardinality
productFirstLineUtcTime	Zero Doppler azimuth time to the mid-slant range of the first line of the image [UTC]. When bi-static correction is performed (bistaticDelayCorrectionApplied set to true) during processing the time annotated is the time of the imaging of the ground. When bi-static correction is not performed the time annotated is the time of the reception of the echo.	timeType	1
productLastLineUtcTime	Zero Doppler azimuth time to the mid-slant range of the last line of the image [UTC]. When bi-static correction is performed (bistaticDelayCorrectionApplied set to true) during processing the time annotated is the time of the imaging of the ground. When bi-static correction is not performed the time annotated is the time of the reception of the echo.	timeType	1
ascendingNodeTime	Time of the Ascending Node Crossing (ANX) prior to the start of the image [UTC].	timeType	1
anchorTime	Zero Doppler reference time used for processing [UTC]. If the product is a slice product, this time is at the time of the first slice within a segment and all slices within the segment report the same time value. Otherwise, this time is the same as the productFirstLineUtcTime.	timeType	1
productComposition	Product composition indicator, where the valid values are: "Individual", to indicate a full non-sliced product; "Slice", to indicate that this is a single slice of a larger product; and "Assembled", to indicate that this is a product that has been created by combining multiple slices.	productCompositionType	1
sliceNumber	If the product composition is type "Slice", this indicates the number of the current slice within the multi-slice segment. If product composition type is "Individual" or "Assembled", the slice number is 0.	uint32	1



# Sentinel-1

Ref: S1-RS-MDA-52-7441  
 MPC Nom: DI-MPC-PB  
 MPC Ref: MPC-0240  
 Issue/Revision: 3/12  
 Date: 19/09/2022

Name	Description	Data Type	Cardinality
sliceList	List of annotations for all slices in segment. The total size of the list represents the number of slices in the segment; that is, there is one slice record for each slice within the segment. If product composition type is “Individual” or “Assembled”, the total size of this list is 0.	sliceListType	1
slantRangeTime	Two-way slant range time to first sample [s].	double	1
pixelValue	Interpretation of the image pixels within the image MDS [Detected or Complex].	pixelValueType	1
outputPixels	Data type of output pixels within the image MDS.	outputPixelsType	1
rangePixelSpacing	Pixel spacing between range samples [m].	float	1
azimuthPixelSpacing	Nominal pixel spacing between range lines [m].	float	1
azimuthTimeInterval	Time spacing between azimuth lines of the output image [s].	double	1
azimuthFrequency	Azimuth line frequency of the output image [Hz]. This is the inverse of the azimuthTimeInterval.	double	1
numberOfSamples	Total number of samples in the output image (image width).	uint32	1
numberOfLines	Total number of lines in the output image (image length).	uint32	1
zeroDopMinusAcqTime	Time difference between zero Doppler time and acquisition time of output image lines [s].	double	1
incidenceAngleMidSwath	Incidence angle at mid swath [degrees].	double	1
imageStatistics	Mean and standard deviation statistics for the image. If the pixelValue field is set to Complex, both the real and imaginary parts of the statistics are reported. If the pixelValue field is set to Detected, only the real parts of the statistics are reported	imageStatisticsType	1

**Table 6-67 Data Type – sliceListType**

Name	Description	Data Type	Cardinality
count	Number of slice records within the list.	unsignedInt	required
slice	Slice record describing a single slice within a multi-slice segment.	sliceType	0 .. 150



# Sentinel-1

Ref: S1-RS-MDA-52-7441  
MPC Nom: DI-MPC-PB  
MPC Ref: MPC-0240  
Issue/Revision: 3/12  
Date: 19/09/2022

**Table 6-68 Data Type - sliceType**

Name	Description	Data Type	Cardinality
sliceNumber	Slice number of the slice to which the information in this record applies.	uint32	1
sensingStartTime	Sensing start time of this slice [UTC].	timeType	1
sensingStopTime	Sensing stop time of this slice [UTC].	timeType	1

**Table 6-69 Data Type - imageStatisticsType**

Name	Description	Data Type	Cardinality
outputDataMean	Mean value of output data.	complex	1
outputDataStdDev	Standard deviation of output data.	complex	1

**Table 6-70 Data Type - processingInformationType**

Name	Description	Data Type	Cardinality
rawDataAnalysisUsed	False if correction was done using default parameters, true if correction was done using raw data analysis.	bool	1
orbitDataFileUsed	True if the orbit data used for processing came from an external file, false if the orbit data used for processing came from the downlink.	bool	1
attitudeDataFileUsed	True if the attitude data used for processing came from an external file, false if the attitude data used for processing came from the downlink.	bool	1
rxVariationCorrectionApplied	False if the receive variation correction was not applied, true if the receive variation correction was applied.	bool	1
antennaElevationPatternApplied	False if antenna elevation pattern correction was not applied, true if antenna elevation pattern correction was applied.	bool	1



# Sentinel-1

Ref: S1-RS-MDA-52-7441  
 MPC Nom: DI-MPC-PB  
 MPC Ref: MPC-0240  
 Issue/Revision: 3/12  
 Date: 19/09/2022

Name	Description	Data Type	Cardinality
antennaAzimuthPatternApplied	False if antenna azimuth pattern correction was not applied, true if antenna azimuth pattern correction was applied.	bool	1
antennaAzimuthElementPattern Applied	False if antenna azimuth element pattern correction was not applied, true if antenna azimuth element pattern correction was applied.	bool	1
dcMethod	Doppler centroid estimation method used during processing. Both the DC calculated from orbit geometry and the DC estimated from the raw data are annotated within the Doppler data set; however, this parameter describes the actual DC method used during image processing.	dcMethodType	1
dcInputData	Type of input data used for Doppler centroid estimation.	dcInputDataType	1
rangeSpreadingLossCompensation Applied	False if range spreading loss compensation was not performed, true if range spreading loss compensation was performed.	bool	1
srgrConversionApplied	False if slant range to ground range conversion has not been performed, true if slant range to ground range conversion has been performed.	bool	1
detectionPerformed	False if detection has not been performed, true if detection has been performed.	bool	1
thermalNoiseCorrectionPerformed	False if thermal noise correction has not been performed, true if thermal noise correction has been performed.	bool	1
rfiMitigationPerformed	Whether or not to perform the RFI mitigation step: if "Always" the RFI mitigation step is always performed; if "Never" the RFI mitigation step is not performed; if "BasedOnNoiseMeas" the preliminary RFI detection from noise measurements decides whether to perform RFI mitigation. If this element is set to "BasedOnNoiseMeas", it is necessary to read the RFI ADS described in Section 6.3.4 to know if the RFI mitigation was performed on a specific MDS.	"Always", "Never", "BasedOnNoiseMeas"	1
rfiMitigationDomain	In case the RFI mitigation step is performed, this flag indicates in what domain it has been applied: "Time", "Frequency", "TimeAndFrequency".	"Time", "Frequency", "TimeAndFrequency"	1
chirpSource	Chirp source used for range compression.	chirpSourceType	1
pgSource	PG source used for processing.	pgSourceType	1
rrfSpectrum	Spectrum of range replica function used.	rrfSpectrumType	1



# Sentinel-1

Ref: S1-RS-MDA-52-7441  
 MPC Nom: DI-MPC-PB  
 MPC Ref: MPC-0240  
 Issue/Revision: 3/12  
 Date: 19/09/2022

Name	Description	Data Type	Cardinality
applicationLutId	Name of the application scaling LUT applied to compensate for the range spreading loss. Set to "None" if no scaling was applied.	string	1
swathProcParamsList	List of processing parameters that may vary per swath.	swathProcParamsListType	1
inputDimensionsList	Input dimensions list. This element contains a list of inputDimensions records which describe the number of input samples and lines.	inputDimensionsListType	1
referenceRange	Range spreading loss reference slant range [m]. The range spreading loss is compensated by amplitude scaling each range sample by $1/Grsl(R)$ where: $Grsl(R) = (rRef/R)^{1/3}$ ; and, R = slant range of sample.	double	1
ellipsoidName	Name of the reference ellipsoid used when processing this product.	string	1
ellipsoidSemiMajorAxis	Semi-major axis of ellipsoid [m].	double	1
ellipsoidSemiMinorAxis	Semi-minor axis of ellipsoid [m].	double	1
bistaticDelayCorrectionApplied	False if bi-static delay correction was not applied, true if bi-static delay correction was applied.	bool	1
topsFilterConvention	Name of the TOPS filter convention used during processing. This field describes how the TOPS ramping/de-ramping filters are defined. If set to "Only Echo Lines" then the filter is defined using only the echo lines in a burst; otherwise, if set to "All Lines" then the filter is defined using all the lines in a burst.	topsFilterConventionType	1
orbitSource	Source of the orbit data used during processing. Set to "Extracted" if the orbit information extracted from the sub-commutated ancillary data in the source packet headers is used during processing. Set to "Auxiliary" if the orbit information from an input auxiliary file is used during processing.	orbitAttitudeSourceType	1
attitudeSource	Source of the attitude data used during processing. Set to "Extracted" if the attitude information extracted from the sub-commutated ancillary data in the source packet headers is used during processing. Set to "Auxiliary" if the attitude information from an input auxiliary file is used during processing.	orbitAttitudeSourceType	1

**Table 6-71 Data Type - swathProcParamsListType**

Name	Description	Data Type	Cardinality
<i>count</i>	<i>Number of processingParameters records within the list.</i>	<i>unsignedInt</i>	<i>required</i>





# Sentinel-1

Ref: S1-RS-MDA-52-7441  
 MPC Nom: DI-MPC-PB  
 MPC Ref: MPC-0240  
 Issue/Revision: 3/12  
 Date: 19/09/2022

Name	Description	Data Type	Cardinality
swathProcParams	Processing parameters. This record contains the range and azimuth processing parameters used to process each input swath in the image. There will be one record per ADS, except for IW/EW GRD products which will contain one per swath.	swathProcParamsType	1 .. 5

**Table 6-72 Data Type - swathProcParamsType**

Name	Description	Data Type	Cardinality
swath	Input swath to which the processing parameters were applied.	swathType	1
rangeProcessing	Range processing information. This record describes the parameters used by the IPF during range processing.	processingParametersType	1
azimuthProcessing	Azimuth processing information. This record describes the parameters used by the IPF during azimuth processing.	processingParametersType	1
processorScalingFactor	Processor scaling factor. This value includes the input scaling factor and the range and azimuth oversampling factors from the auxiliary input and is applied multiplicatively to the image data during processing. This is the value referred to as $k_{proc}$ in [R-14]	float	1

**Table 6-73 Data Type - processingParametersType**

Name	Description	Data Type	Cardinality
windowType	Name of the weighting window type used during processing.	weightingWindowType	1
windowCoefficient	Value of the weighting window coefficient used during processing.	double	1
totalBandwidth	Total available bandwidth [Hz].	double	1
processingBandwidth	Bandwidth used during processing [Hz].	double	1
lookBandwidth	Bandwidth for each look used during processing [Hz].	double	1
numberOfLooks	Number of looks.	uint32	1



# Sentinel-1

Ref: S1-RS-MDA-52-7441  
 MPC Nom: DI-MPC-PB  
 MPC Ref: MPC-0240  
 Issue/Revision: 3/12  
 Date: 19/09/2022

Name	Description	Data Type	Cardinality
lookOverlap	Overlap between looks [Hz].	double	1

**Table 6-74 Data Type - inputDimensionsListType**

Name	Description	Data Type	Cardinality
<i>count</i>	<i>Number of inputDimensions records within the list.</i>	<i>unsignedInt</i>	<i>required</i>
inputDimensions	Input dimensions. This record contains the dimensions of the input data in terms of number of input samples and lines. For individual scene and slice products there is one inputDimensions record, except in the case of IW/EW GRD products which contain one record per swath. For assembled products the list contains all the inputDimensions records for each slice included in the assembled product. For a minimum output slice length of 10s, a maximum segment length of 25 minutes and a maximum of 5 swaths, the maximum number of records in the list is 750.	inputDimensionsType	1 .. 750

**Table 6-75 Data Type - inputDimensionsType**

Name	Description	Data Type	Cardinality
azimuthTime	Zero Doppler azimuth time to which this set of dimensions applies [UTC].	timeType	1
swath	Input swath to which the dimensions apply.	swathType	1
numberOfInputSamples	Number of input samples for the image or slice.	uint32	1
numberOfInputLines	Number of input lines for the image or slice.	uint32	1

### 6.3.1.4 Doppler Centroid Data Set Record

Doppler centroid data set record. This DSR contains information about the Doppler centroid values estimated and used during image processing.



## Sentinel-1

Ref: S1-RS-MDA-52-7441  
MPC Nom: DI-MPC-PB  
MPC Ref: MPC-0240  
Issue/Revision: 3/12  
Date: 19/09/2022

Figure 6-18 presents a graphical view of the structure and content of the image ADSR and the subsequent tables describe the schemas defined in Appendix A2.

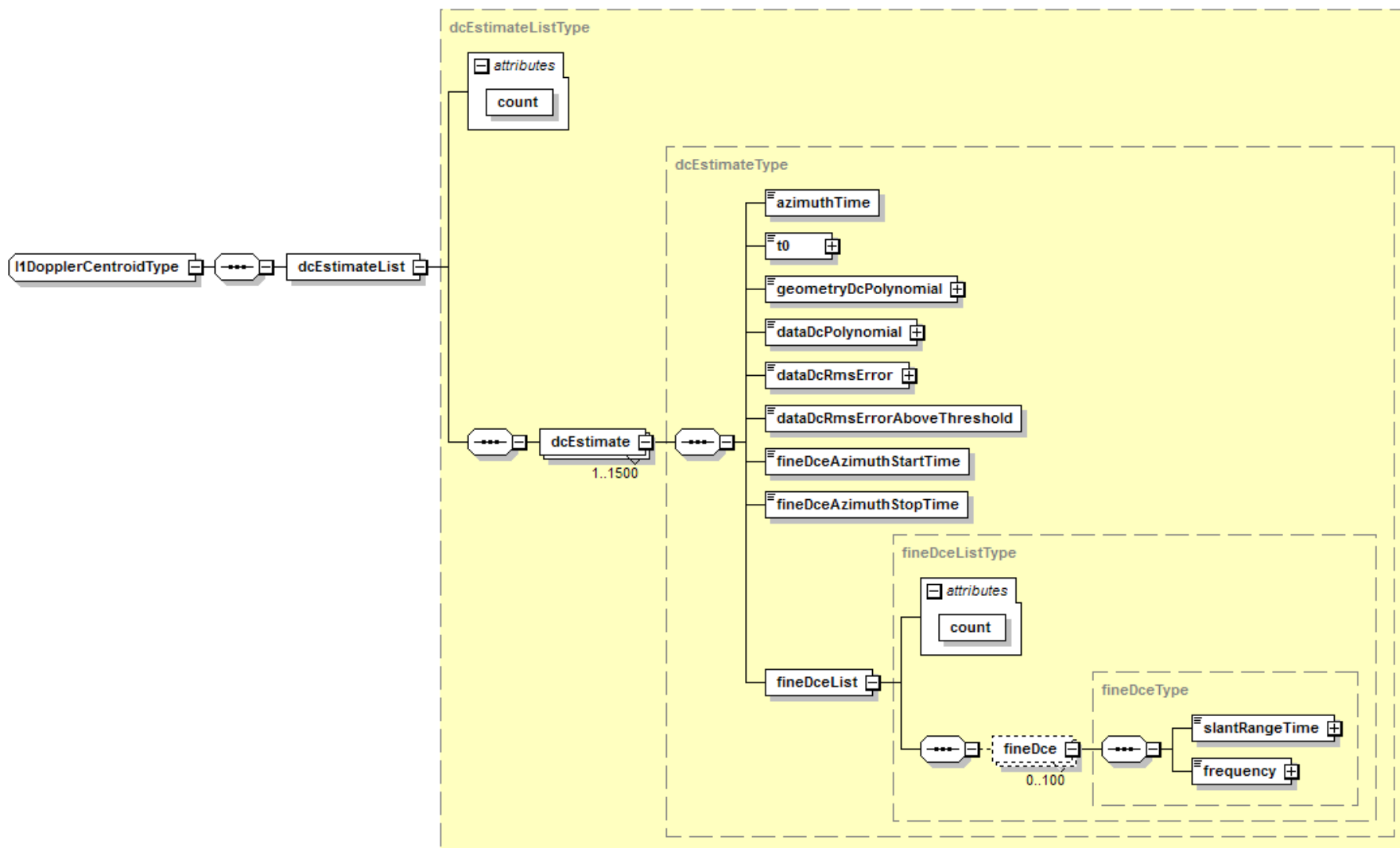

Figure 6-18 L1 Doppler Centroid ADSR



**Table 6-76 Data Type - l1DopplerCentroidType**

Name	Description	Data Type	Cardinality
dcEstimateList	List of Doppler centroid estimates that have been calculated by the IPF during image processing. The list contains an entry for each Doppler centroid estimate made along azimuth.	dcEstimateListType	1

**Table 6-77 Data Type - dceBlockListType**

Name	Description	Data Type	Cardinality
<i>Count</i>	<i>Number of dcEstimate records within the list.</i>	<i>unsignedInt</i>	<i>required</i>
dcEstimate	Doppler centroid estimate record which contains the Doppler centroid calculated from geometry and estimated from the data, associated signal-to-noise ratio values and indicates which DCE method was used by the IPF during image processing. With a minimum Doppler centroid update rate of 1s (for IW and EW where the Doppler is recalculated for every burst cycle) and a maximum product length of 25 minutes, the maximum size of this list is 1500 elements.	dcEstimateType	1 .. 1500

**Table 6-78 Data Type - dcEstimateType**

Name	Description	Data Type	Cardinality
azimuthTime	Zero Doppler azimuth time of this Doppler centroid estimate [UTC]. This time represents the centre of the block used to calculate the fine DC estimates used to derive the data DC polynomial.	timeType	1
t0	Two-way slant range time origin for Doppler centroid estimate [s].	double	1
geometryDcPolynomial	Doppler centroid estimated from orbit, expressed as the following polynomial (assuming 5 coefficients): $DopplerCentroid = d_0 + d_1(t_{SR} - t_0) + d_2(t_{SR} - t_0)^2 + d_3(t_{SR} - t_0)^3 + d_4(t_{SR} - t_0)^4$ where tSR = 2 way slant range time.	floatCoefficientArray	1



# Sentinel-1

Ref: S1-RS-MDA-52-7441  
 MPC Nom: DI-MPC-PB  
 MPC Ref: MPC-0240  
 Issue/Revision: 3/12  
 Date: 19/09/2022

Name	Description	Data Type	Cardinality
dataDcPolynomial	Doppler centroid estimated from data, expressed as the following polynomial (assuming 5 coefficients): $DopplerCentroid = d_0 + d_1(t_{SR} - t_0) + d_2(t_{SR} - t_0)^2 + d_3(t_{SR} - t_0)^3 + d_4(t_{SR} - t_0)^4$ where tSR = 2 way slant range time.	floatCoefficientArray	1
dataDcRmsError	The RMS error of the Doppler centroid estimate. It is calculated as the average of the individual RMS residual errors between input fine Doppler centroid estimates and the fitted polynomial. If the Doppler centroid was not estimated from data, this is set to 0.	double	1
dataDcRmsErrorAboveThreshold	False if the RMS error is below the acceptable threshold for the Doppler centroid estimated from the data. True if the RMS error is greater than or equal to the acceptable threshold.	bool	1
fineDceAzimuthStartTime	First zero Doppler azimuth time of the block of signal data used for the fine DC estimates [UTC].	timeType	1
fineDceAzimuthStopTime	Last zero Doppler azimuth time of the block of signal data used for the fine DC estimates [UTC].	timeType	1
fineDceList	List of the fine Doppler centroid estimates for this block. This element is a list of fineDce records which contain the fine Doppler centroid frequencies that were used for fitting the data polynomial for this block.	fineDceListType	1

**Table 6-79 Data Type - fineDceListType**

Name	Description	Data Type	Cardinality
<i>count</i>	<i>Number of Doppler centroid estimates in the list.</i>	<i>unsignedInt</i>	<i>required</i>
fineDce	Fine Doppler centroid estimate. Each estimate represents the Doppler frequency at the given slant range time within the current block. Approximately 20 estimates are performed per swath so for 5 swaths, the maximum number of estimates in this list is 100.	fineDceType	0 .. 100



**Table 6-80 Data Type - fineDceType**

Name	Description	Data Type	Cardinality
slantRangeTime	Two way slant range time to Doppler centroid frequency estimate [s].	double	1
frequency	Fine Doppler centroid frequency estimate [Hz].	double	1

### 6.3.1.5 Antenna Elevation Pattern Data Set Record

Antenna elevation pattern (AEP) data set record. This DSR contains information describing the elevation antenna pattern and how it was applied by the IPF during image processing.

Figure 6-19 presents a graphical view of the structure and content of the Antenna Pattern ADSR and the subsequent tables describe the schemas defined in Appendix A2.

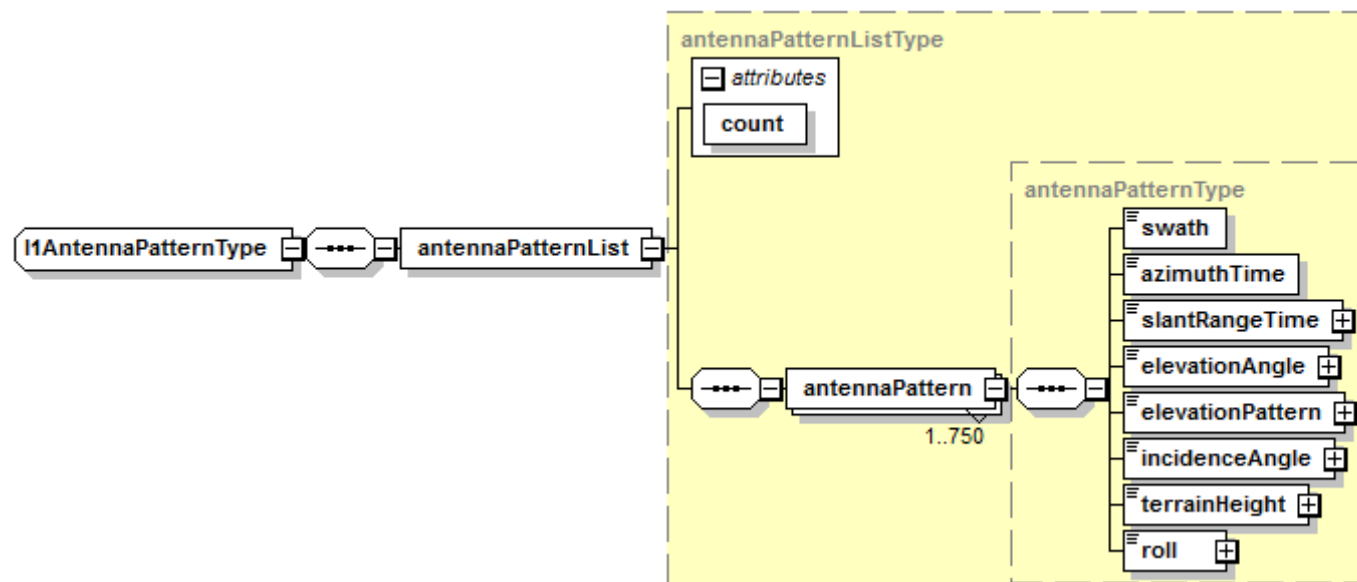

**Figure 6-19 L1 Antenna Elevation Pattern ADSR**

**Table 6-81 Data Type - I1AntennaPatternType**

Name	Description	Data Type	Cardinality
antennaPatternList	Antenna pattern list. This element is a list of antennaPattern records that describe the antenna elevation pattern as it is updated in azimuth. The list contains an entry for each AEP update made along azimuth.	antennaPatternListType	1

**Table 6-82 Data Type - antennaPatternListType**

Name	Description	Data Type	Cardinality
count	Number of antenna pattern records within the list.	unsignedInt	required





# Sentinel-1

Ref: S1-RS-MDA-52-7441  
 MPC Nom: DI-MPC-PB  
 MPC Ref: MPC-0240  
 Issue/Revision: 3/12  
 Date: 19/09/2022

Name	Description	Data Type	Cardinality
antennaPattern	The antenna pattern record describes the antenna elevation pattern at the given zero Doppler azimuth time for a given swath. For a minimum azimuth antenna pattern spacing of 10s, a maximum segment length of 25 minutes and a maximum 5 swaths, the maximum number of records in the list is 750.	antennaPatternType	1 .. 750

**Table 6-83 Data Type - antennaPatternType**

Name	Description	Data Type	Cardinality
swath	Swath to which the elevation antenna pattern applies.	swathType	1
azimuthTime	Zero Doppler azimuth time at which antenna pattern applies [UTC].	timeType	1
slantRangeTime	Two-way slant range time array for this antenna pattern [s]. This array contains the count attribute number of double floating point values (i.e. one value per point in the antenna pattern), separated by spaces.	doubleArray	1
elevationAngle	Corresponding elevation angle for this antenna pattern [degrees]. This array contains the count attribute number of floating point values (i.e. one value per point in the antenna pattern), separated by spaces. This array contains the same number of values as the slantRangeTime array.	floatArray	1
elevationPattern	Corresponding two-way antenna elevation pattern value for this point. This array contains the count attribute number of complex floating point values (i.e. one value per point in the antenna pattern), separated by spaces in the order I Q I Q I Q ... This array contains the same number of values as the slantRangeTime array.	complexArray	1
incidenceAngle	Corresponding incidence angle value for this point. This array contains the count attribute number of floating point values (i.e. one value per point in the antenna pattern), separated by spaces [degrees]. This array contains the same number of values as the slantRangeTime array.	floatArray	1
terrainHeight	Average terrain height in range for this antenna pattern [m].	double	1
roll	Estimated roll angle for this antenna pattern [degrees].	double	1



## Sentinel-1

Ref: S1-RS-MDA-52-7441  
MPC Nom: DI-MPC-PB  
MPC Ref: MPC-0240  
Issue/Revision: 3/12  
Date: 19/09/2022

### 6.3.1.6 Swath Timing Data Set Record

Swath timing data set record. This DSR contains the information about the bursts within the image MDS including the burst dimensions, burst timing and burst location. This DSR is specific to IW and EW SLC products.

Figure 6-20 presents a graphical view of the structure and content of the Swath Timing ADSR and the subsequent tables describe the schemas defined in Appendix A2.

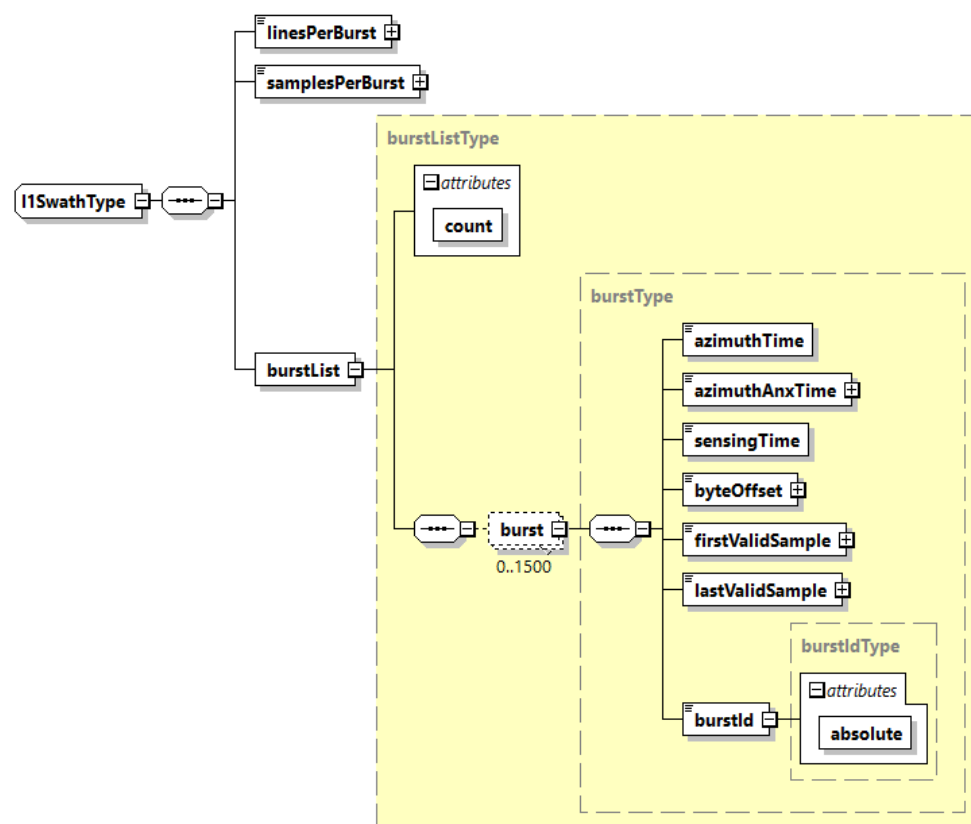

**Figure 6-20 L1 Swath Timing ADSR**



**Table 6-84 Data Type - IISwathType**

Name	Description	Data Type	Cardinality
linesPerBurst	Number of range lines within each burst (constant for all bursts within the swath).	uint32	1
samplesPerBurst	Number of range samples within each burst (constant for all bursts within the swath).	uint32	1
burstList	Burst list. This element contains a time ordered list of all the bursts within this swath. The list contains a burst record for each burst within this swath. This list is only applicable to IW and EW SLC products and has a length of zero for all others.	burstListType	1

**Table 6-85 Data Type - burstListType**

Name	Description	Data Type	Cardinality
<i>count</i>	<i>Number of burst records within the list.</i>	<i>unsignedInt</i>	<i>required</i>
burst	Burst table entry. This record contains the information for a single burst entry including the dimensions of the burst, the timing of the burst and where it is located within the image MDS. With an approximate burst cycle time of 1s and a maximum product length of 25 minutes, the maximum size of this list is 1500 elements.	burstType	0 .. 1500

**Table 6-86 Data Type - burstIdType**

Name	Description	Data Type	Cardinality
<i>absolute</i>	<i>Attribute specifying an absolute and unique identifier for each burst cycle since the start of the mission. Note that different platforms and different modes (IW and EW) have separate numberings.</i>	<i>unsignedLong</i>	<i>required</i>



# Sentinel-1

Ref: S1-RS-MDA-52-7441  
 MPC Nom: DI-MPC-PB  
 MPC Ref: MPC-0240  
 Issue/Revision: 3/12  
 Date: 19/09/2022

Name	Description	Data Type	Cardinality
	<p>An identification number that uniquely identifies a burst cycle within each mission repeat cycle (12 days). As S-1 bursts are synchronized from pass to pass, a correspondence can be made between the burst ID of a given sub swath and a specific region on Earth's surface. Note that the annotated burst ID is mode-dependent; that is, IW and EW acquisitions have different numberings.</p> <p>Under specific circumstances, e.g. collision avoidance manoeuvres or burst de-synchronization, the burst ID sequence may be impacted with repetitions or gaps.</p>	unsignedInt	1

**Table 6-87 Data Type - burstType**

Name	Description	Data Type	Cardinality
azimuthTime	Zero Doppler azimuth time of the first line of this burst [UTC].	timeType	1
azimuthAnxTime	Zero Doppler azimuth time of the first line of this burst relative to the Ascending Node Crossing (ANX) time. [s].	double	1
sensingTime	Sensing time of the first input line of this burst [UTC].	timeType	1
byteOffset	Byte offset of this burst within the image MDS.	uint64	1
firstValidSample	An array of integers indicating the offset of the first valid image sample within each range line. This array contains count attribute integers, equal to the linesPerBurst field (i.e. one value per range line within the burst), separated by spaces. If a range line does not contain any valid image samples, the integer is set to -1.	intArray	1
lastValidSample	An array of integers indicating the offset of the last valid image sample within each range line. This array contains count attribute integers, equal to the linesPerBurst (i.e. one value per range line within the burst), separated by spaces. If a range line does not contain any valid image samples, the integer is set to -1.	intArray	1
burstId	An identification number that uniquely identifies a burst cycle within each mission repeat cycle (12 days). See Section 9.25 of [R-14] for a detailed description of the burst ID calculation method.	burstIdType	1



## Sentinel-1

Ref: S1-RS-MDA-52-7441  
MPC Nom: DI-MPC-PB  
MPC Ref: MPC-0240  
Issue/Revision: 3/12  
Date: 19/09/2022

### 6.3.1.7 Geo-location Grid Data Set Record

Geo-location grid data set record. This DSR describes the geodetic position (latitude and longitude) of line/pixel combinations within the image MDS.

Before IPF version 3.2.0, the geo-location grid data set did not provide independent heights for each grid point. In fact, the altitude was updated according to the azimuthTime of each entry, but in the slantRangeTime dimension the altitude was updated only once per swath. Starting from IPF 3.2.0, the altitude varies for each ground control point.

Figure 6-21 presents a graphical view of the structure and content of the Geo-location Grid ADSR and the subsequent tables describe the schemas defined in Appendix A2.

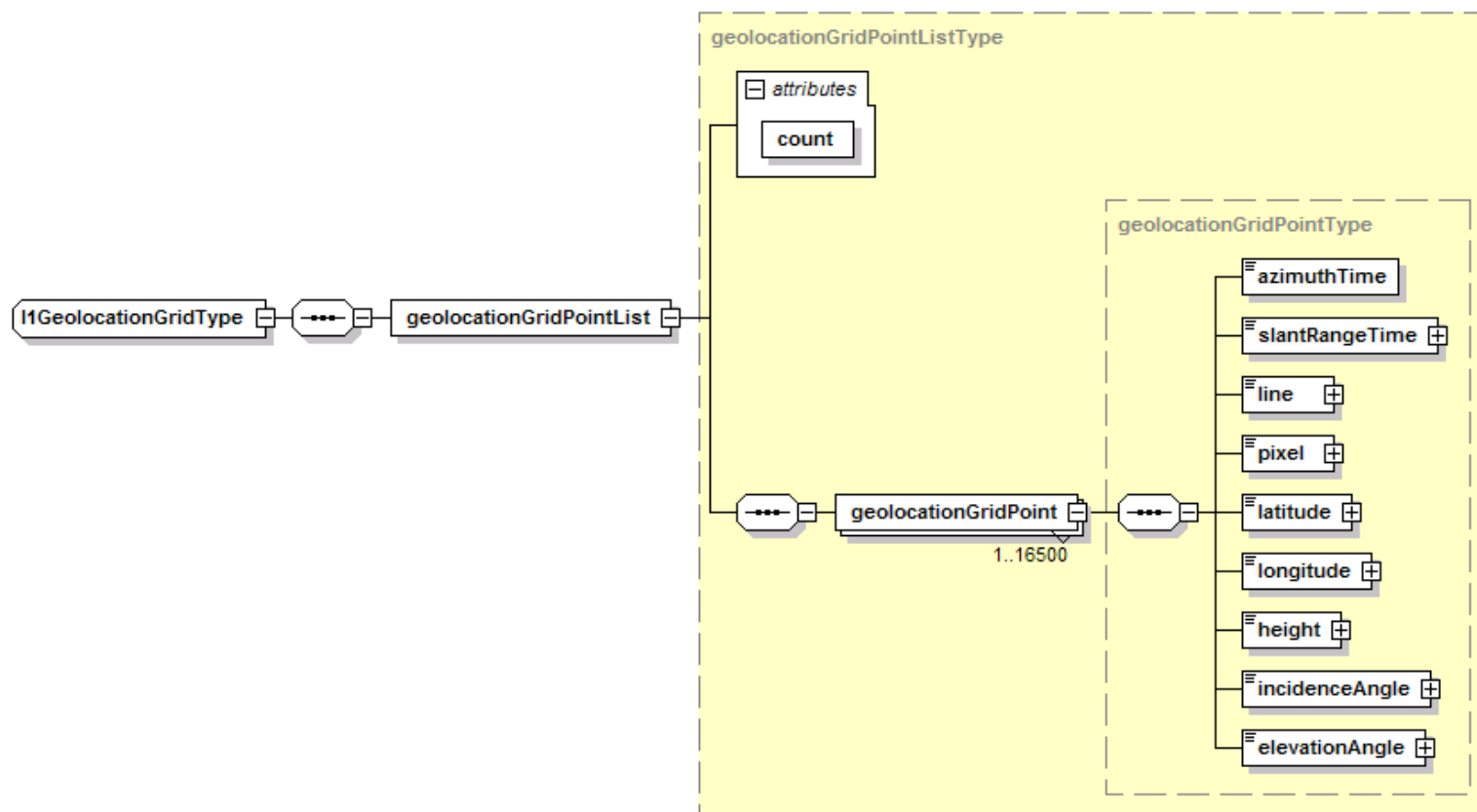

Figure 6-21 L1 Geo-location Grid ADSR



**Table 6-88 Data Type - 11GeolocationGridType**

Name	Description	Data Type	Cardinality
geolocationGridPointList	Geolocation grid. This element is a list of geolocationGridPoint records which contains grid point entries for each line/pixel combination based on a configured resolution. The list contains an entry for each update made along azimuth.	geolocationGridPointListType	1

**Table 6-89 Data Type - geolocationGridPointListType**

Name	Description	Data Type	Cardinality
<i>count</i>	<i>Number of geolocation grid point records within the list.</i>	<i>unsignedInt</i>	<i>required</i>
geolocationGridPoint	Geolocation grid point. This record describes geolocation information for a single point (line/pixel combination) within the image MDS. For 11 geolocation grid points across range and a new set of points calculated every 1s in azimuth, for a maximum product length of 25 minutes, the maximum size of this list is 16500 elements.	geolocationGridPointType	1 ..16500

**Table 6-90 Data Type - geolocationGridPointType**

Name	Description	Data Type	Cardinality
azimuthTime	Zero Doppler azimuth time to which grid point applies [UTC].	timeType	1
slantRangeTime	Two way slant range time to grid point [s].	double	1
line	Reference image MDS line to which this geolocation grid point applies.	uint32	1
pixel	Reference image MDS sample to which this geolocation grid point applies.	uint32	1
latitude	Geodetic latitude of grid point [degrees].	double	1
longitude	Geodetic longitude of grid point [degrees].	double	1
height	Height of the grid point above sea level [m].	double	1





# Sentinel-1

Ref: S1-RS-MDA-52-7441  
MPC Nom: DI-MPC-PB  
MPC Ref: MPC-0240  
Issue/Revision: 3/12  
Date: 19/09/2022

Name	Description	Data Type	Cardinality
incidenceAngle	Incidence angle to grid point [degrees].	double	1
elevationAngle	Elevation angle to grid point [degrees].	double	1

### 6.3.1.8 Coordinate Conversion Data Set Record

Coordinate conversion data set record. This DSR contains the annotations required to convert pixels within the image MDS between the slant range and ground range coordinate systems.

Figure 6-22 presents a graphical view of the structure and content of the Coordinate Conversion ADSR and the subsequent tables describe the schemas defined in Appendix A2.

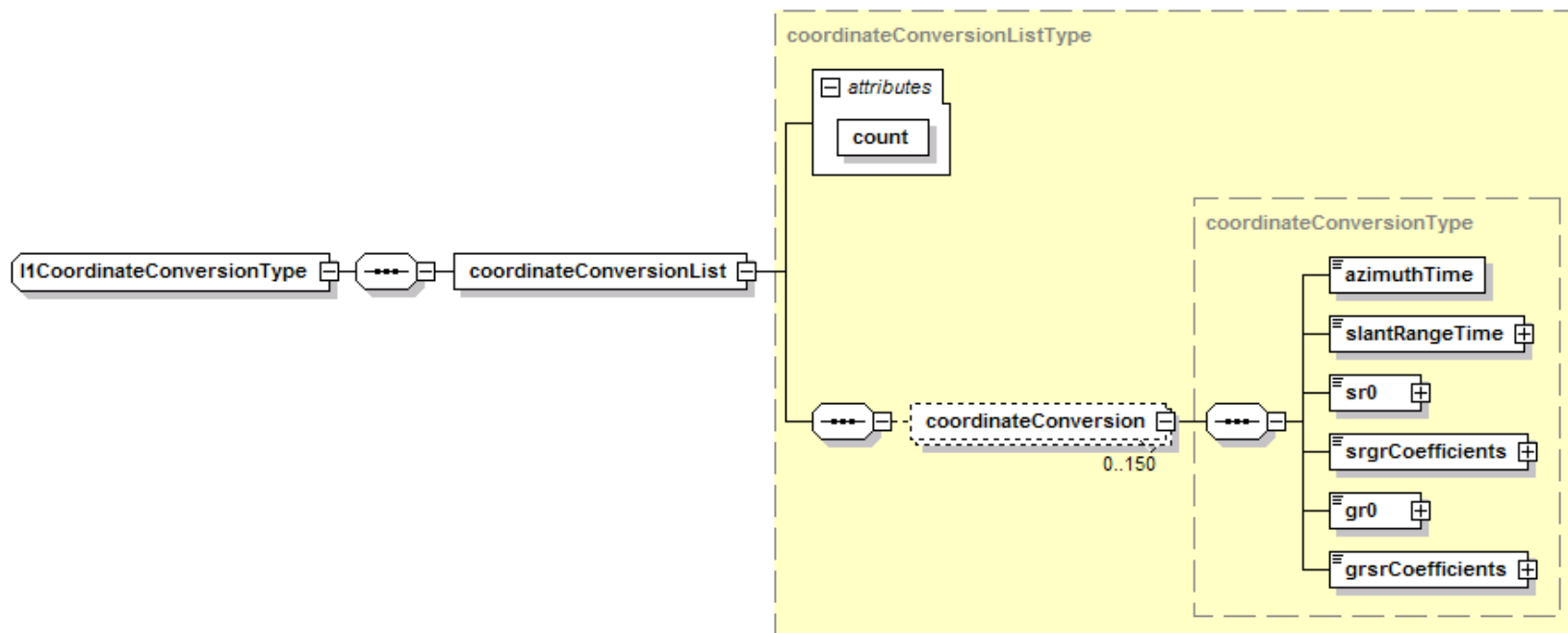

**Figure 6-22 L1 Coordinate Conversion ADSR**

**Table 6-91 Data Type - I1CoordinateConversionType**

Name	Description	Data Type	Cardinality
coordinateConversionList	Coordinate conversion list. This element is a list of coordinateConversion records that describe conversion between the slant range and ground range coordinate systems. The list contains an entry for each update made along azimuth. This list applies to and is filled in only for GRD products and therefore has a length of zero for SLC products.	coordinateConversionListType	1



**Table 6-92 Data Type - coordinateConversionListType**

Name	Description	Data Type	Cardinality
count	Number of coordinateConversion records within the list.	unsignedInt	required
coordinateConversion	The polynomial used to convert image pixels between slant range and ground range. The polynomials are time-stamped with the zero Doppler azimuth and two way slant range times to which they apply. The coefficients used on range lines between updates are found by linear interpolation between the updated and previous values. For a minimum spacing of 1s between coordinateConversion record updates and a maximum acquisition length of 25 minutes, the maximum number of records in the list is 1500.	coordinateConversionType	0 .. 1500

**Table 6-93 Data Type - coordinateConversionType**

Name	Description	Data Type	Cardinality
azimuthTime	Zero Doppler azimuth time at which parameters apply [UTC].	timeType	1
slantRangeTime	Two way slant range time to first range sample [s].	double	1
sr0	Slant range origin used for ground range calculation [m].	double	1
srgrCoefficients	Polynomial to convert from slant range to ground range. The order of polynomial n is given by the count attribute -1.  The generic polynomial expression is $GroundRange = g_0 + g_1(sr - sr_0) + g_2(sr - sr_0)^2 + \dots + g_{n-1}(sr - sr_0)^{n-1}$ where sr is the slant range distance to the desired pixel.	doubleCoefficientArray	1
gr0	Ground range origin used for slant range calculation [m].	double	1
grsrCoefficients	Polynomial to convert from ground range to slant range coefficients. The order of polynomial n is given by the count attribute -1.  The generic polynomial expression is	doubleCoefficientArray	1



Name	Description	Data Type	Cardinality
	$SlantRange = s_0 + s_1(gr - gr_0) + s_2(gr - gr_0)^2 + \dots + s_{n-1}(gr - gr_0)^{n-1}$ <p>where gr is the ground range distance to the desired pixel.</p>		

### 6.3.1.9 Swath Merging Data Set Record

Swath merging data set record. This DSR contains the annotations for interpreting the way in which IW or EW swaths were merged during GRD processing. The purpose of this DSR is to provide the information necessary to unambiguously identify the boundaries of each swath within the image MDS.

Figure 6-23 presents a graphical view of the structure and content of the Swath Merging ADSR and the subsequent tables describe the schemas defined in Appendix A2. At the end of this section, Figure 6-24 illustrates what the swath merging annotations may look like for two possible scenarios. The simple case is one in which the optimal range cut line is constant for all swaths and does not change over the azimuth extent of the image and the more complex case is one in which the optimal range cut line varies for all swaths and is updated multiple times over the azimuth extent of the image.

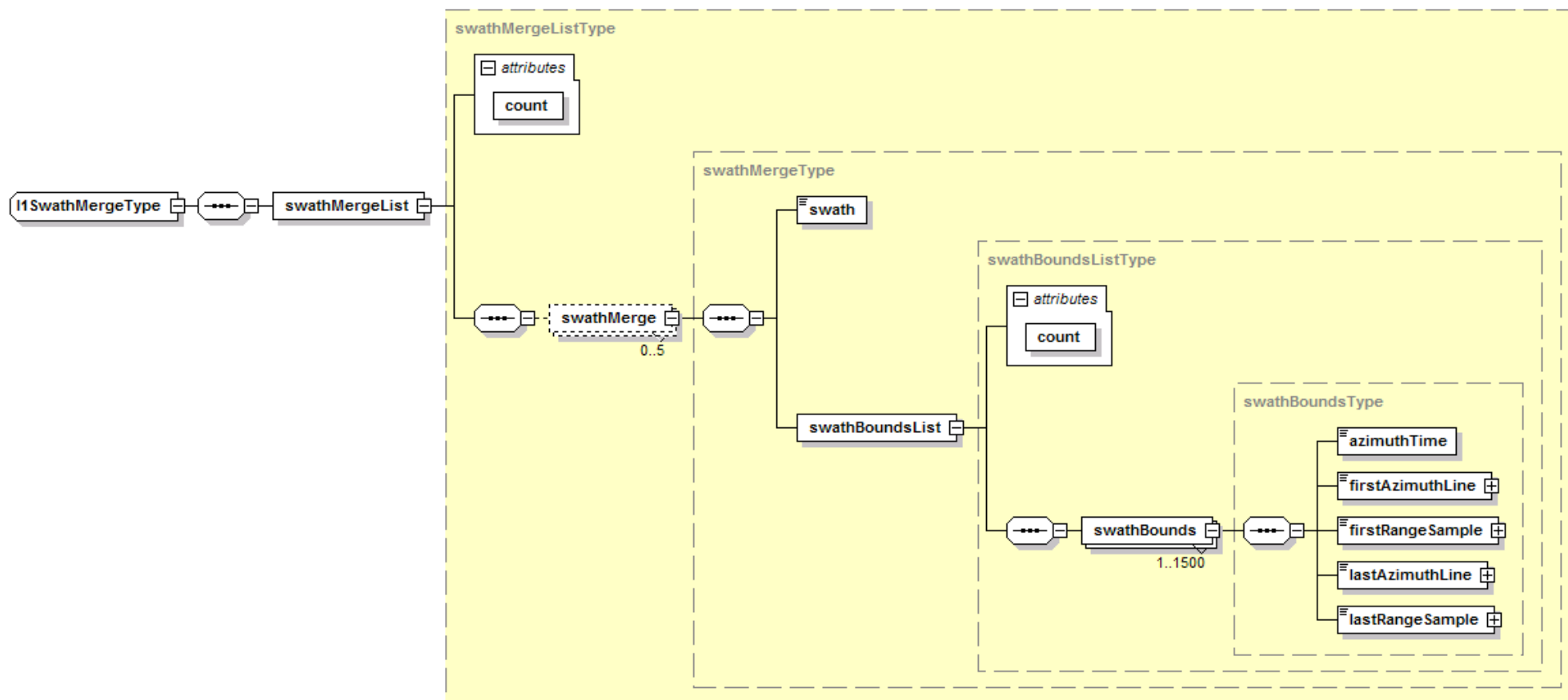

Figure 6-23 L1 Swath Merging ADSR



**Table 6-94 Data Type - IISwathMergeType**

Name	Description	Data Type	Cardinality
swathMergeList	Merge information for IW and EW GRD products. This list contains one record per swath.	swathMergeListType	1

**Table 6-95 Data Type - swathMergeListType**

Name	Description	Data Type	Cardinality
<i>count</i>	<i>Number of swathMerge records within the list.</i>	<i>unsignedInt</i>	<i>required</i>
swathMerge	This record contains the information needed to identify where each burst of the given swath was merged within the image MDS.	swathMergeType	0 .. 5

**Table 6-96 Data Type - swathMergeType**

Name	Description	Data Type	Cardinality
swath	Swath to which swath merging information applies.	swathType	1
swathBoundsList	This list contains the information needed to identify where the current swath has been merged into the image MDS. Each swathBounds record represents a rectangular area that may include several burst merged in azimuth. These records do not describe where individual bursts were merged in azimuth, within a swath.	swathBoundsListType	1



**Table 6-97 Data Type - swathBoundsListType**

Name	Description	Data Type	Cardinality
<i>count</i>	<i>Number of swath bounds records within the list.</i>	<i>unsignedInt</i>	<i>required</i>
swathBounds	Swath boundary record. This record contains the information needed to identify the position of the swath within the image. The swath boundary is identified by a rectangular area defined by the points (firstRangeSample, firstAzimuthLine) and (lastRangeSample, lastAzimuthLine). The optimal range cut line can vary in azimuth and so a new record is included for each swath boundary update in azimuth. It is important to note that the information on the azimuth cut line is lost and not represented by these annotations. Although a line in azimuth is implicitly created by each bounding box, this does not necessarily represent the azimuth cut line used during swath merging. For an average spacing of 1s between swath bound updates and a maximum acquisition length of 25 minutes, the maximum number of records in the list is 1500.	swathBoundsType	1 .. 1500

**Table 6-98 Data Type - swathBoundsType**

Name	Description	Data Type	Cardinality
azimuthTime	Zero Doppler azimuth time of firstAzimuthLine [UTC].	timeType	1
firstAzimuthLine	First azimuth line of the swath boundary [lines]. This point represents the azimuth origin of the swath boundary.	uint32	1
firstRangeSample	First range sample of the swath boundary [samples]. This point represents the range origin of the swath boundary.	uint32	1
lastAzimuthLine	Last azimuth line of the swath boundary [lines]. Relative to the firstAzimuthLine, this point represents the azimuth extent of the swath boundary.	uint32	1
lastRangeSample	Last range sample of the swath boundary [samples]. Relative to the firstRangeSample, this point represents the range extent of the swath boundary.	uint32	1



## Sentinel-1

Ref: S1-RS-MDA-52-7441  
MPC Nom: DI-MPC-PB  
MPC Ref: MPC-0240  
Issue/Revision: 3/12  
Date: 19/09/2022

The annotations for the simple case in the graph below contain a single `swathBoundsType` entry for each swath that represents a bounding box covering the entire azimuth extent of the image. The annotations in the complex case contain multiple `swathBoundsType` entries for each swath – 4, 6 and 3 for IW1, IW2 and IW3 respectively – that collectively describe the location of the swaths within the image. To identify the applicable set of annotations for each bounding box the notation  $iwM(n)_y^x$  is used where M is the swath number – 1, 2 or 3, n is the index of the `swathBoundsType` annotation increasing as the optimal range cut line changes in azimuth and the superscript/subscript pair  $x/y$  describes a point in the image defined by (firstRangeSample, firstAzimuthLine) or (lastRangeSample, lastAzimuthLine).



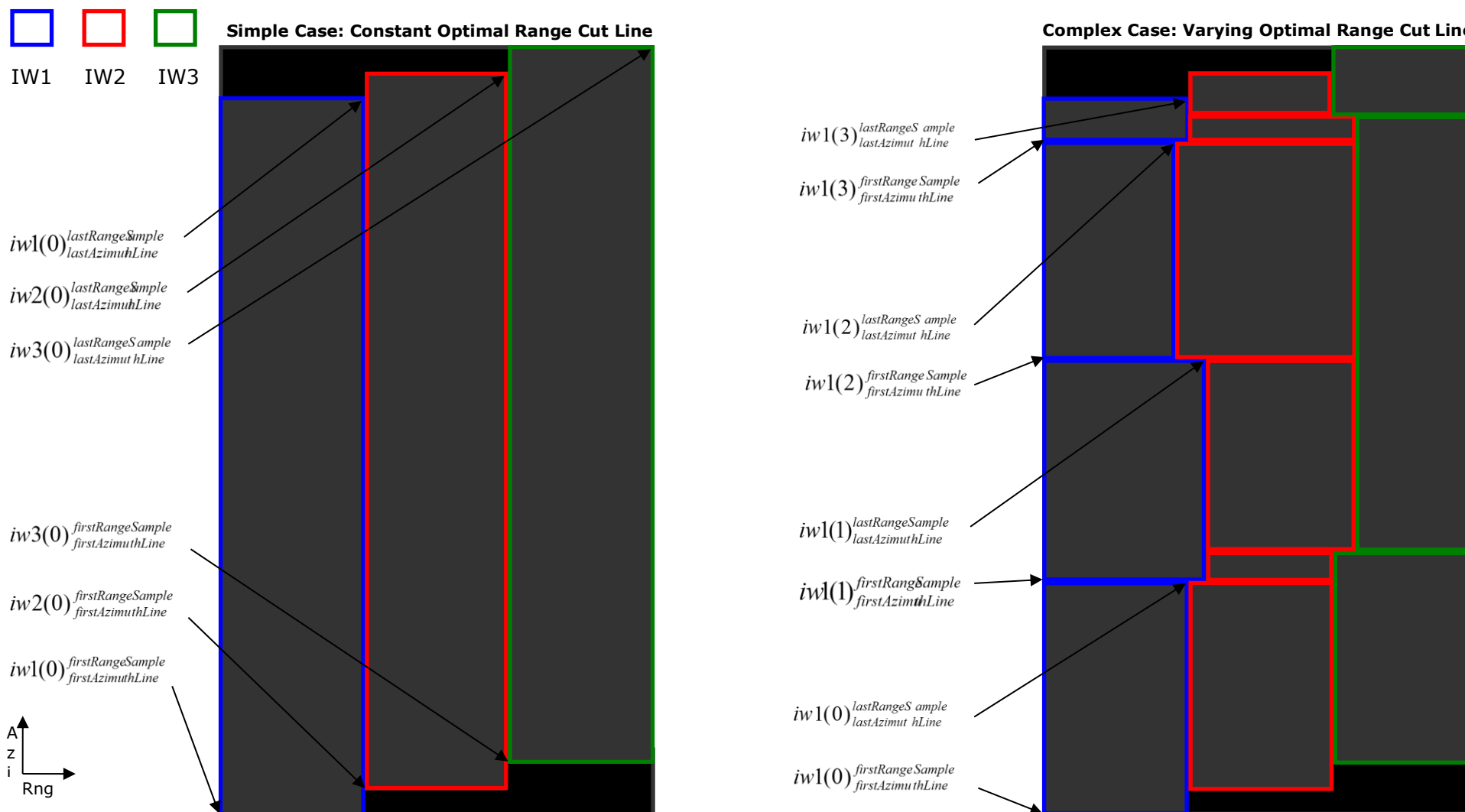

**Figure 6-24 Swath Merging**

### 6.3.2 L1 Calibration Annotation Data Set

The L1 Calibration ADS provides four calibration LUTs with every product. Applying any of these tables undoes the application output scaling introduced by the processor and scales the image to achieve the desired type of absolute calibration, notably:

Three of these LUTs allow one to convert the digital numbers in the image MDS into  $\beta^0$ ,  $\sigma^0$  or  $\gamma$  radiometrically calibrated imagery – depending on which LUT is used – by applying a range dependent gain (and a constant offset in the GRD case) to the image data. Note that in order to achieve the desired calibration the absolute calibration constant  $K_{abs}$  (absoluteCalibrationConstant), has also been built into these tables. The fourth LUT, the *dn* LUT allows one to recover the original DN value that the image had before the scaling by the application LUT (therefore the *dn* LUT does not include the external calibration factor  $K_{abs}$ ).

In order to convert the DN of a given range pixel  $i$  in a Sentinel-1 SAR image to a calibrated value or the original DN, the user has to apply one of the following formulae:

$$value(i) = \frac{|DN_i|^2}{A_i^2}$$

where, depending on the selected LUT:

$$value(i) = \text{one of } \beta^0_i, \sigma^0_i \text{ or } \gamma_i \text{ or } originalDN_i.$$

$$A_i = \text{one of } betaNought(i), sigmaNought(i), gamma(i) \text{ or } dn(i)$$

For any pixel  $i$  that falls between points in the LUT the value is found by bilinear interpolation.

Figure 6-25 presents a graphical view of the structure and content of the L1 Calibration LUT Data Set and the subsequent tables describe the schemas defined in Appendix A3.

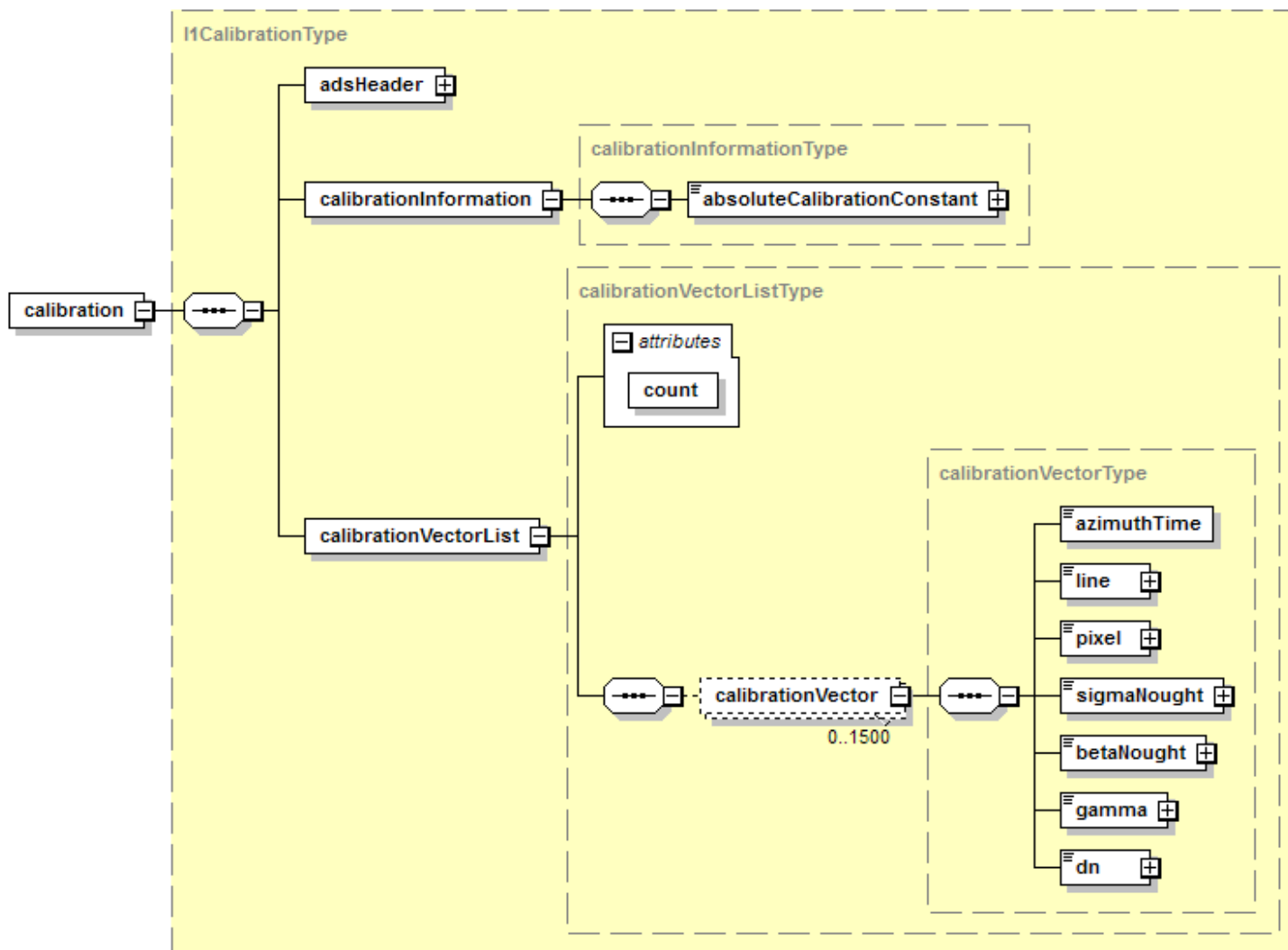

Figure 6-25 L1 Calibration Data Set



**Table 6-99 Element - calibration**

Name	Description	Data Type	Cardinality
adsHeader	ADS header data set record. This DSR contains information that applies to the entire data set.	adsHeaderType	1
calibrationInformation	Calibration information. This DSR holds parameters applicable to the image calibration.	calibrationInformationType	1
calibrationVectorList	Calibration vector list. This element is a list of calibrationVector records that contain the absolute calibration vectors required to derive radiometrically calibrated imagery from the image MDS. The list contains an entry for each update made along azimuth.	calibrationVectorListType	1

**Table 6-100 Data Type - calibrationInformationType**

Name	Description	Data Type	Cardinality
absoluteCalibrationConstant	Swath dependent absolute calibration constant ( $K_{abs}$ ). This value comes from the auxiliary input and is built in to the absolute calibration vectors sigmaNought, betaNought and gamma.	double	1

**Table 6-101 Data Type - calibrationVectorListType**

Name	Description	Data Type	Cardinality
<i>count</i>	<i>Number of calibrationVector records within the list.</i>	<i>unsignedInt</i>	<i>required</i>
calibrationVector	Calibration vector record. This record holds the calibration vectors and associated fields required to derive radiometrically calibrated imagery from the image MDS. With a minimum calibration vector update rate of 1s and a maximum product length of 25 minutes, the maximum size of this list is 1500 elements. The azimuth spacing used will be different for different modes and product types.	calibrationVectorType	0 .. 1500



# Sentinel-1

Ref: S1-RS-MDA-52-7441  
MPC Nom: DI-MPC-PB  
MPC Ref: MPC-0240  
Issue/Revision: 3/12  
Date: 19/09/2022

**Table 6-102 Data Type - calibrationVectorType**

Name	Description	Data Type	Cardinality
azimuthTime	Zero Doppler azimuth time at which calibration vector applies.	timeType	1
line	Image line at which the calibration vector applies.	int32	1
pixel	Image pixel at which the calibration vector applies. This array contains the count attribute number of integer values (i.e. one value per point in the calibration vectors), separated by spaces. The maximum length of this array will be one value for every pixel in an image line, however in general the vectors will be subsampled.	intArray	1
sigmaNought	Sigma nought calibration vector. This array contains the count attribute number of floating point values separated by spaces. The values in this vector are aligned with the pixel vector.	floatArray	1
betaNought	Beta nought calibration vector. This array contains the count attribute number of floating point values separated by spaces. The values in this vector are aligned with the pixel vector.	floatArray	1
gamma	Gamma calibration vector. This array contains the count attribute number of floating point values separated by spaces. The values in this vector are aligned with the pixel vector.	floatArray	1
dn	Digital number calibration vector. This array contains the count attribute number of floating point values separated by spaces. The values in this vector are aligned with the pixel vector.	floatArray	1

### 6.3.3 L1 Noise Annotation Data Set

The L1 Noise ADS provides a LUT – with values provided in linear power – that can be used to derive calibrated noise profiles which match the calibrated GRD data.

More specifically, in order to convert the values provided in the noise LUT to  $\beta^0$ ,  $\sigma^0$  or  $\gamma$  calibrated noise or to the noise estimated by the IPF during SLC processing, the noise LUT must be scaled by the corresponding calibration LUT ( $\beta^0$ ,  $\sigma^0$  or  $\gamma$  or  $dn$ , respectively):

$$noise(i) = \frac{\eta_i}{A_i^2}$$

where, depending on the LUT selected to calibrate the image data:

- $noise(i)$  = calibrated noise profile for one of  $\beta^0_i$ ,  $\sigma^0_i$  or  $\gamma_i$  or *originalDN<sub>i</sub>*
- $\eta_i$  = *noiseLut(i)*
- $A_i$  = one of *betaNought(i)*, *sigmaNought(i)*, *gamma(i)*, *dn(i)*

Once the calibrated noise profile has been obtained as above, the noise can be removed from the GRD data by subtraction.

It is also possible to obtain calibrated data and remove the estimated noise in one step by considering the subtraction of the noise in the formula described in 6.3.2 as follows:

$$value(i) = \frac{(DN_i^2 - \eta_i)}{A_i^2}$$

For any pixel  $i$  that falls between points in the LUT the value is found by bilinear interpolation.

Figure 6-26 presents a graphical view of the structure and content of the L1 Noise LUT Data Set and the subsequent tables describe the schemas defined in Appendix A4.

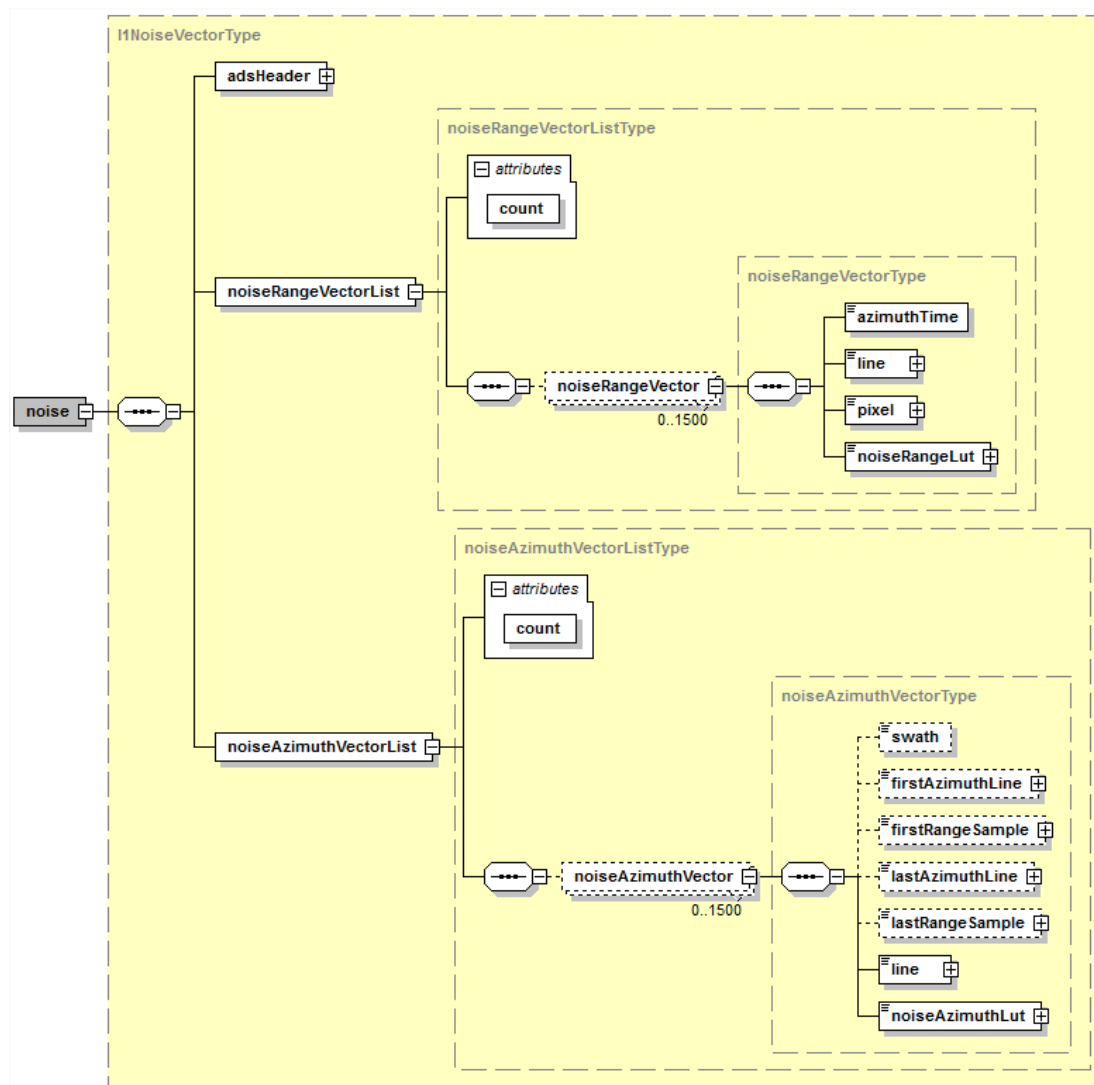

Figure 6-26 L1 Noise LUT Data Set



# Sentinel-1

Ref: S1-RS-MDA-52-7441  
 MPC Nom: DI-MPC-PB  
 MPC Ref: MPC-0240  
 Issue/Revision: 3/12  
 Date: 19/09/2022

**Table 6-103 Element - noise**

Name	Description	Data Type	Cardinality
adsHeader	ADS header data set record. This DSR contains information that applies to the entire data set.	adsHeaderType	1
noiseRangeVectorList	Range noise vector list. This element is a list of noiseRangeVector records that contain the range thermal noise estimation for the image MDS. The list contains an entry for each update made along azimuth.	noiseRangeVectorListType	1
noiseAzimuthVectorList	Azimuth noise vector list. This annotation divides the image in blocks providing a list of azimuth noise vector records that contain the thermal noise estimation for the block. The block belongs to a (sub-)swath (i.e. it can't cross by design two swaths) and it is delimited by firstAzimuthLine, lastAzimuthLine, firstRangeSample, lastRangeSample.  This specific annotation is provided since IPF version 2.90.	noiseAzimuthVectorListType	0 or 1

**Table 6-104 Data Type - noiseRangeVectorListType**

Name	Description	Data Type	Cardinality
count	<i>Number of noiseRangeVector records within the list.</i>	unsignedInt	required
noiseRangeVector	Noise range vector. This record contains the thermal noise estimation annotations which can be used to remove thermal noise from the image. With a minimum noise vector update rate of 1s and a maximum product length of 25 minutes, the maximum size of this list is 1500 elements. The azimuth spacing used will be different for different modes and product types.  Note: the noise removal can create negative values that requires to be clipped. The clipping is made such that it is not possible to recover the original pixel values if one wants to re-instate the noise vector.	noiseRangeVectorType	0 .. 1500

**Table 6-105 Data Type - noiseRangeVectorType**

Name	Description	Data Type	Cardinality
azimuthTime	Zero Doppler azimuth time at which noise vector applies.	timeType	1





# Sentinel-1

Ref: S1-RS-MDA-52-7441  
 MPC Nom: DI-MPC-PB  
 MPC Ref: MPC-0240  
 Issue/Revision: 3/12  
 Date: 19/09/2022

Name	Description	Data Type	Cardinality
line	Image line at which the noise vector applies.	int32	1
pixel	Image pixel at which the noise vector applies. This array contains the count attribute number of integer values (i.e. one value per point in the noise vector), separated by spaces. The maximum length of this array will be one value for every pixel in an image line, however in general the vectors will be subsampled.	intArray	1
noiseRangeLut	Range thermal noise correction vector power values. This array contains the count attribute number of floating point values separated by spaces.	floatArray	1

**Table 6-106 Data Type - noiseAzimuthVectorListType**

Name	Description	Data Type	Cardinality
<i>count</i>	<i>Number of noiseAzimuthVector records within the list.</i>	<i>unsignedInt</i>	<i>required</i>
noiseAzimuthVector	Noise azimuth vector. This record contains the thermal noise estimation annotations which can be used to remove thermal noise from the image.  Note: the noise removal can create negative values that requires to be clipped. The clipping is made such that it is not possible to recover the original pixel values if one wants to re-instate the noise vector.	noiseAzimuthVectorType	0 .. 1500

**Table 6-107 Data Type - noiseAzimuthVectorType**

Name	Description	Data Type	Cardinality
swath	Swath to which the noise vector applies.	swathType	0 .. 1
firstAzimuthLine	The first line at which this annotation applies.	uint32	0 .. 1
firstRangeSample	The first sample at which this annotation applies.	uint32	0 .. 1



# Sentinel-1

Ref: S1-RS-MDA-52-7441  
MPC Nom: DI-MPC-PB  
MPC Ref: MPC-0240  
Issue/Revision: 3/12  
Date: 19/09/2022

Name	Description	Data Type	Cardinality
lastAzimuthLine	The last line at which this annotation applies.	uint32	0 .. 1
lastRangeSample	The last sample at which this annotation applies.	uint32	0 .. 1
line	Image line at which the noise vector applies. This array contains the count attribute number of integer values (i.e. one value per point in the noise vector), separated by spaces. The maximum length of this array will be one value for every line in an image pixel, however in general the vectors will be subsampled.	intArray	1
noiseAzimuthLut	Azimuth thermal noise correction vector power values. This array contains the count attribute number of floating point values separated by spaces.	floatArray	1

## 6.3.4 L1 RFI Annotation Data Set

This section describes in detail the content of the RFI Annotation Data Set. The aim of this ADS is to provide the user with a detailed report about the radio frequency interference detected and mitigated by the L1 processor. The main pieces of information are:

- A flag indicating which kind of RFI mitigation technique was applied (none/time-domain/frequency-domain/time and frequency domains).
- A report about the RFI detected from noise measurements (rfiDetectionFromNoiseReportList). This element is present only if RFI detection from noise measurement is active.
- A report containing statistics about the time-domain RFI mitigation algorithm (if applicable).
- A report containing statistics about the frequency-domain RFI mitigation algorithm (if applicable).

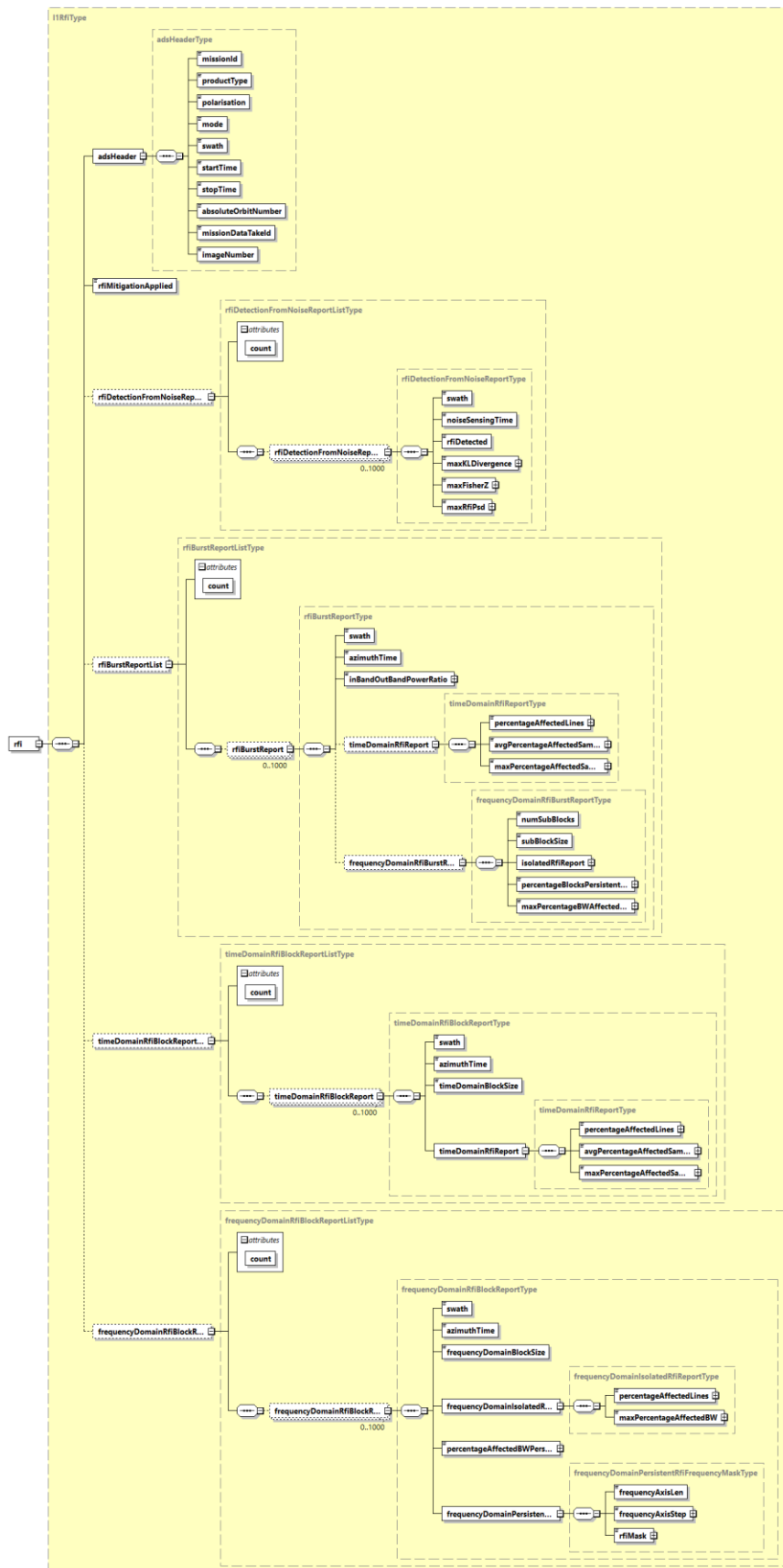

Figure 6-27 L1 RFI Data Set



# Sentinel-1

Ref: S1-RS-MDA-52-7441  
 MPC Nom: DI-MPC-PB  
 MPC Ref: MPC-0240  
 Issue/Revision: 3/12  
 Date: 19/09/2022

**Table 6-108 Element - rfi**

Name	Description	Data Type	Cardinality
adsHeader	ADS header data set record. This DSR contains information that applies to the entire data set.	adsHeaderType	1
rfiMitigationApplied	Type of RFI mitigation algorithm applied to the data set. If “None” no RFI mitigation algorithm was applied to the data, if “Time” the time-domain RFI mitigation algorithm was applied, if “Frequency” the frequency-domain RFI mitigation algorithm was applied, if “TimeFrequency” both time and frequency domain RFI mitigation algorithms were applied.	“None”, “Time”, “Frequency”, “TimeFrequency”	1
rfiDetectionFromNoiseReportList	RFI report list of the RFI detections performed on each noise sequence.	rfiDetectionFromNoiseReportListType	0-1
rfiBurstReportList	RFI report list at burst level. This element is a list of rfiBurstReport records that contain the time and frequency domain reports for each burst of the data set. This element can only be present in EW and IW modes if either time-domain or frequency-domain RFI mitigations are performed.	rfiBurstReportListType	0-1
timeDomainRfiBlockReportList	Time domain RFI report list at processing block level. This element is a list of timeDomainRfiBlockReport records that contain the time domain reports for each block of the data set. This element can only be present in SM and WV modes if time-domain RFI mitigation is performed.	timeDomainRfiBlockReportListType	0-1
frequencyDomainRfiBlockReportList	Frequency domain RFI report list at processing block level. This element is a list of frequencyDomainRfiBlockReport records that contain the frequency domain reports for each block of the data set. This element can only be present in SM and WV modes if frequency-domain RFI mitigation is performed.	frequencyDomainRfiBlockReportListType	0-1



# Sentinel-1

Ref: S1-RS-MDA-52-7441  
 MPC Nom: DI-MPC-PB  
 MPC Ref: MPC-0240  
 Issue/Revision: 3/12  
 Date: 19/09/2022

**Table 6-109 Element - rfiDetectionFromNoiseReportList**

Name	Description	Data Type	Cardinality
<i>count</i>	<i>Number of rfiDetectionFromNoiseReport records within the list.</i>	<i>unsignedInt</i>	<i>1</i>
rfiDetectionFromNoiseReport	This record contains an RFI detection report associated to a noise sequence	rfiDetectionFromNoiseReportType	0-1000

**Table 6-110 Element - rfiDetectionFromNoiseReport**

Name	Description	Data Type	Cardinality
swath	Swath to which the RFI report applies.	swathType	1
noiseSensingTime	Sensing time of the noise sequence [UTC].	timeType	1
rfiDetected	True if RFI was detected in the noise sequence.	bool	1
maxKLDivergence	Maximum value of the KL divergence statistic in the noise sequence.	float	1
maxFisherZ	Maximum value of Fisher's Z statistic in the noise sequence.	float	1
maxRfiPsd	Maximum power spectral density recorded in a frequency bin containing RFI. It is zero if no RFI was found.	float	1



# Sentinel-1

Ref: S1-RS-MDA-52-7441  
 MPC Nom: DI-MPC-PB  
 MPC Ref: MPC-0240  
 Issue/Revision: 3/12  
 Date: 19/09/2022

**Table 6-111 Element - rfiBurstReportList**

Name	Description	Data Type	Cardinality
<i>count</i>	<i>Number of rfiBurstReport records within the list.</i>	<i>unsignedInt</i>	<i>1</i>
rfiBurstReport	RFI report at burst level. This record contains the time and frequency domain reports for a single TOPSAR burst.	rfiBurstReportType	0-1000

**Table 6-112 Element - rfiBurstReportType**

Name	Description	Data Type	Cardinality
swath	Swath to which the RFI report applies.	swathType	1
azimuthTime	Zero Doppler azimuth time of the first line of the burst [UTC].	timeType	1
inBandOutBandPowerRatio	Ratio between the in-band and out-of-band power of the burst.	float	1
timeDomainRfiReport	RFI report of the time-domain mitigation.	timeDomainRfiReportType	0-1
frequencyDomainRfiBurstReport	Frequency domain RFI report at burst level. Even if the frequency-domain mitigation algorithm subdivides the lines of the burst in multiple sub-blocks, this element only provides an aggregated report.	frequencyDomainRfiBurstReportType	0-1



# Sentinel-1

Ref: S1-RS-MDA-52-7441  
 MPC Nom: DI-MPC-PB  
 MPC Ref: MPC-0240  
 Issue/Revision: 3/12  
 Date: 19/09/2022

**Table 6-113 Element - timeDomainRfiReport**

Name	Description	Data Type	Cardinality
percentageAffectedLines	Percentage of level-0 lines affected by RFI.	float	1
avgPercentageAffectedSamples	Average percentage of affected level-0 samples in the lines containing RFI.	float	1
maxPercentageAffectedSamples	Maximum percentage of level-0 samples affected by RFI in the same line.	float	1

**Table 6-114 Element - frequencyDomainRfiBurstReport**

Name	Description	Data Type	Cardinality
numSubBlocks	Number of sub-blocks in the current burst.	unsignedInt	1
subBlockSize	Number of lines in each sub-block.	unsignedInt	1
isolatedRfiReport	Report about the isolated RFI tones detected. In this case the RFI detection is performed line-by-line on the L0 product.	frequencyDomainIsolatedRfiReportType	1
percentageBlocksPersistentRfi	Percentage of processing blocks affected by persistent RFI. In this case the RFI detection is performed on the mean PSD of each processing block.	float	1
maxPercentageBWAffectedPersistentRfi	Max percentage bandwidth affected by persistent RFI in a single processing block.	float	1





# Sentinel-1

Ref: S1-RS-MDA-52-7441  
 MPC Nom: DI-MPC-PB  
 MPC Ref: MPC-0240  
 Issue/Revision: 3/12  
 Date: 19/09/2022

**Table 6-115 Element - isolatedRfiReport**

Name	Description	Data Type	Cardinality
percentageAffectedLines	Percentage of level-0 lines affected by isolated RFI.	float	1
maxPercentageAffectedBW	Max. percentage of bandwidth affected by isolated RFI in a single line.	float	1

**Table 6-116 Element - timeDomainRfiBlockReportList**

Name	Description	Data Type	Cardinality
<i>count</i>	<i>Number of timeDomainRfiBlockReport records within the list.</i>	<i>unsignedInt</i>	<i>1</i>
timeDomainRfiBlockReport	RFI time-domain report at block level. This record contains the time domain reports for a single processing block.	timeDomainRfiBlockReportType	0-1000

**Table 6-117 Element - timeDomainRfiBlockReport**

Name	Description	Data Type	Cardinality
swath	Swath to which the RFI report applies.	swathType	1
azimuthTime	Zero Doppler azimuth time of the first line of the processing block [UTC].	timeType	1
timeDomainBlockSize	Number of lines in the time-domain block.	unsignedInt	1



# Sentinel-1

Ref: S1-RS-MDA-52-7441  
 MPC Nom: DI-MPC-PB  
 MPC Ref: MPC-0240  
 Issue/Revision: 3/12  
 Date: 19/09/2022

Name	Description	Data Type	Cardinality
timeDomainRfiReport	RFI report of the time-domain mitigation.	timeDomainRfiReportType	1

**Table 6-118 Element - frequencyDomainRfiBlockReportList**

Name	Description	Data Type	Cardinality
<i>count</i>	<i>Number of frequencyDomainRfiBlockReport records within the list.</i>	<i>unsignedInt</i>	<i>1</i>
frequencyDomainRfiBlockReport	RFI frequency-domain report at block level. This record contains the frequency domain reports for a single processing block.	frequencyDomainRfiBlockReportType	0-1000

**Table 6-119 Element - frequencyDomainRfiBlockReport**

Name	Description	Data Type	Cardinality
swath	Swath to which the RFI report applies.	swathType	1
azimuthTime	Zero Doppler azimuth time of the first line of the processing block [UTC].	timeType	1
frequencyDomainBlockSize	Number of lines in the frequency-domain block.	unsignedInt	1
frequencyDomainIsolatedRfiReport	Frequency-domain RFI report for the isolated RFIs detected.	frequencyDomainIsolatedRfiReportType	1
percentageAffectedBWPersistentRFI	Percentage of bandwidth affected by persistent RFI.	float	1



# Sentinel-1

Ref: S1-RS-MDA-52-7441  
 MPC Nom: DI-MPC-PB  
 MPC Ref: MPC-0240  
 Issue/Revision: 3/12  
 Date: 19/09/2022

Name	Description	Data Type	Cardinality
frequencyDomainPersistentRfiFrequencyMask	Frequency mask of the persistent RFI found in the block	frequencyDomainPersistentRfiFrequencyMaskType	1

**Table 6-120 Element - frequencyDomainPersistentRfiFrequencyMask**

Name	Description	Data Type	Cardinality
frequencyAxisLen	Number of bins in the frequency axis	unsignedInt	1
frequencyAxisStep	Step in Hertz between frequency axis bins.	float	1
rfiMask	Frequency mask of the persistent RFI found in the block.	intArray	1

## 6.3.5 Map Overlay Annotation Data Set

The map overlay data set is a Keyhole Markup Language (KML) file [R-10] that describes the product coverage area and is suitable for viewing in any application that supports KML. Figure 6-28 shows a graphical example of the map overlay in which the composite Quick-look image from Section 6.2.2 is geo-referenced and displayed as an overlay in Google Earth.

The map overlay data set contains the KML elements required to select the L1 or L2 product's Quick-look images, position it on the map and display it. Figure 6-29 presents a graphical view of the XML structure of the map overlay data set and the content and structure are presented in the subsequent tables. Note that data types in the following tables that are prefixed with "kml:" are part of the KML specification [R-10] and types prefixed with "gx:" are part of the Google extensions to KML [R-13].

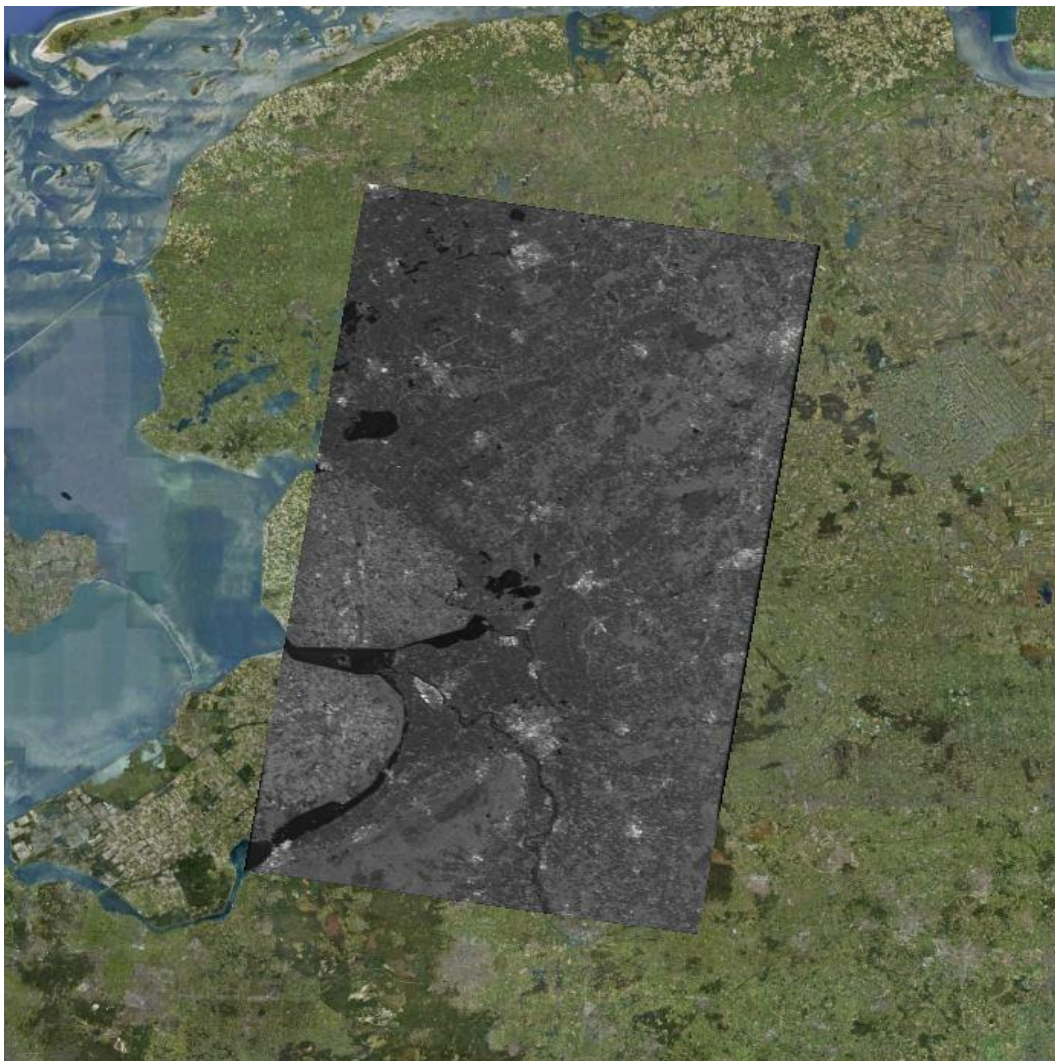

**Figure 6-28 Sentinel-1 Map Overlay Displayed in Google Earth**

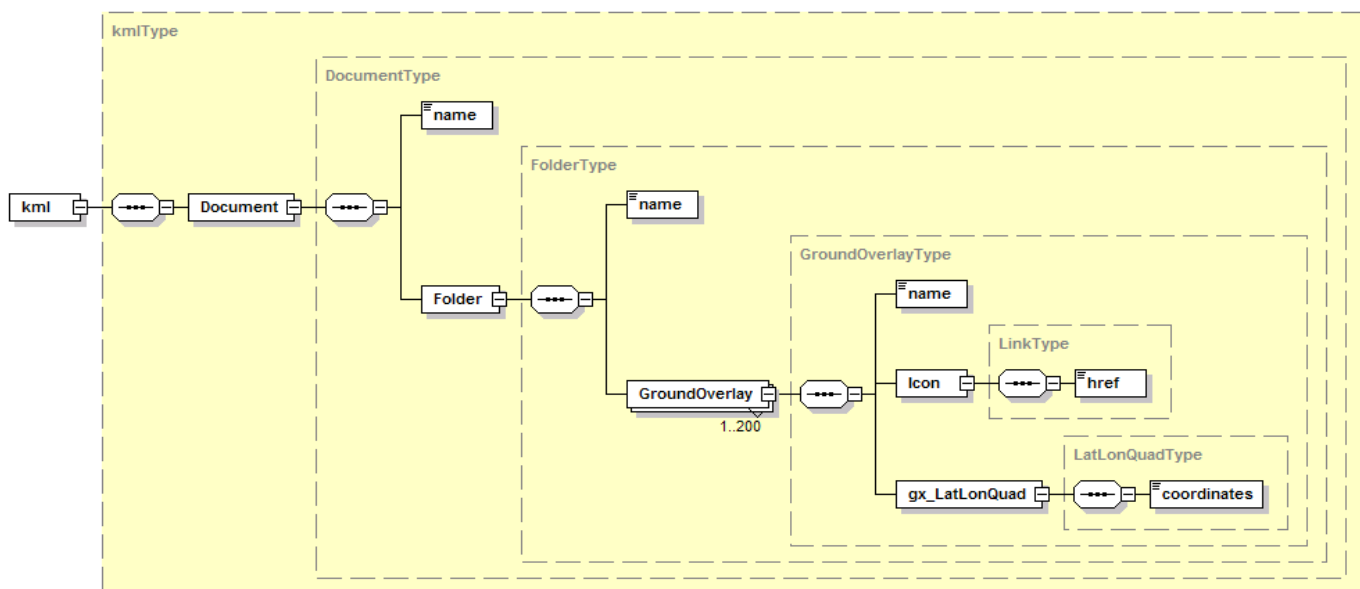

**Figure 6-29 Map Overlay Annotation Data Set**

**Table 6-121 Root element - kml**

Name	Description	Data Type	Cardinality
Document	Document container for KML components.	Kml:DocumentType	1

**Table 6-122 Data Type – kml:DocumentType**

Name	Description	Data Type	Cardinality
name	Name of the document.	String	1
Folder	There shall always be at least one Folder element containing at least one GroundOverlay element. Two folders are provided in TOPS and SM L2 products (since IPF 3.60) in order to provide information to overlay the 2 types of L2 quick-look images. (rv1 and owi)	kml:FolderType	1, 2

**Table 6-123 Data Type – kml:FolderType**

Name	Description	Data Type	Cardinality
name	Name of the folder.	String	1
GroundOverlay	Contains the parameters required to specify the footprint of the image and overlay the quick-look images (if included with the product) on a map. For Wave images, there will be one GroundOverlay per vignette.	Kml:GroundOverlayType	1 .. 200

**Table 6-124 Data Type - kml:GroundOverlayType**

Name	Description	Data Type	Cardinality
name	A descriptive name for the map overlay. This will typically be set to the name of the product folder.	String	1
icon	This structure describes the image file used on the map overlay.	kml:LinkType	0..1
gx:LatLonQuad	Contains the latitude and longitude coordinates used to position the image overlay on the map.	gx:LatLonQuadType	1

**Table 6-125 Data Type - kml:LinkType**

Name	Description	Data Type	Cardinality
href	A local file specification or URL used to load the desired image and overlay it on the map.	String	1

**Table 6-126 Data Type - gx:LatLonQuadType**

Name	Description	Data Type	Cardinality
coordinates	A string of 4 lon, lat coordinate pairs which describe the corners of the image. The string is of the form:  lon,lat lon,lat lon,lat lon,lat  The coordinates must appear in the following order: last line first pixel, last line last pixel, first line last pixel, first line first pixel	String	1

## 6.3.6 Product Preview Annotation Data Set

The Product Preview is a Hypertext Markup Language (HTML) file that presents a graphical overview of the product through use of the Quick-look MDS and provides access to the data sets within the product through a simple user interface of HTML hyperlinks to the product files on the local file system. The Product Preview ADS is formatted using an XML style sheet which may be modified to refine the look of the HTML page, and so the ADS may evolve over time. Figure 6-30 and Figure 6-31 show examples of what the Product Preview might look like and Table 6-127 lists the content included in the product preview ADS.



**S1B\_IW\_GRDH\_1SDV\_20211112T101254\_20211112T101323\_029553\_0386ED**

[manifest.safe](#)

#### annotation

- [s1b-iw-grd-vh-20211112t101254-20211112t101323-029553-0386ed-002.xml](#)
- [s1b-iw-grd-vv-20211112t101254-20211112t101323-029553-0386ed-001.xml](#)

#### annotation/calibration

- [noise-s1b-iw-grd-vh-20211112t101254-20211112t101323-029553-0386ed-002.xml](#)
- [noise-s1b-iw-grd-vv-20211112t101254-20211112t101323-029553-0386ed-001.xml](#)
- [calibration-s1b-iw-grd-vh-20211112t101254-20211112t101323-029553-0386ed-002.xml](#)
- [calibration-s1b-iw-grd-vv-20211112t101254-20211112t101323-029553-0386ed-001.xml](#)

#### annotation/rfi

- [rfi-s1b-iw-grd-vh-20211112t101254-20211112t101323-029553-0386ed-002.xml](#)
- [rfi-s1b-iw-grd-vv-20211112t101254-20211112t101323-029553-0386ed-001.xml](#)

#### measurement

- [s1b-iw-grd-vh-20211112t101254-20211112t101323-029553-0386ed-002.tiff](#)
- [s1b-iw-grd-vv-20211112t101254-20211112t101323-029553-0386ed-001.tiff](#)

#### preview

- [map-overlay.kml](#)
- [product-preview.html](#)
- [quick-look.png](#)

#### preview/icons

- [logo.png](#)

#### support

- [s1-level-1-product.xsd](#)
- [s1-level-1-noise.xsd](#)
- [s1-level-1-rfi.xsd](#)
- [s1-level-1-calibration.xsd](#)
- [s1-object-types.xsd](#)
- [s1-map-overlay.xsd](#)
- [s1-product-preview.xsd](#)
- [s1-level-1-measurement.xsd](#)
- [s1-level-1-quicklook.xsd](#)

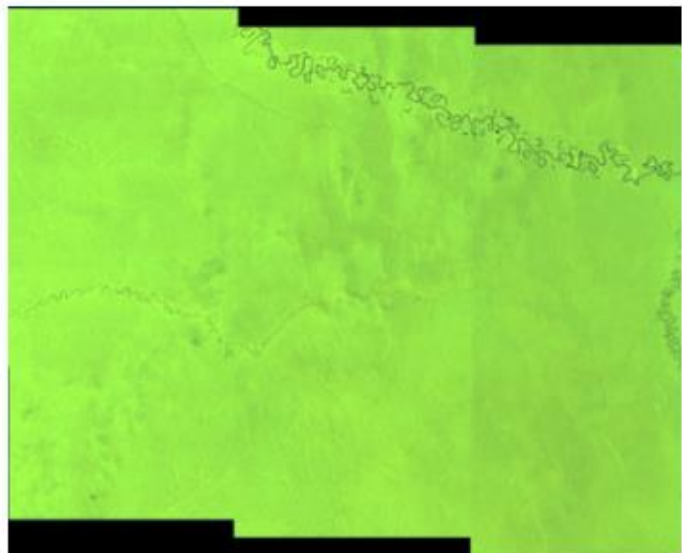

Figure 6-30 Example Product Preview ADS



S1B\_IW\_OCN\_2SDV\_20180514T183525\_20180514T183550\_010921\_013FBC

[manifest.safe](#)

#### icons

- [logo.png](#)

#### measurement

- [s1b-iw-ocn-vv-20180514t183523-20180514t183551-010921-013FBC-001.nc](#)

#### preview RVL

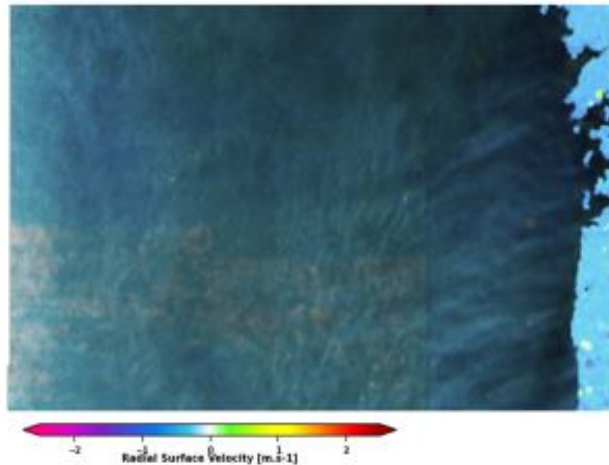

#### preview OWI

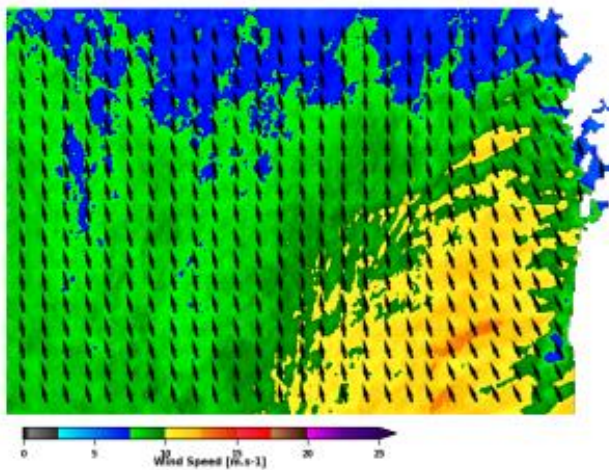

#### preview

- [map-overlay.kml](#)
- [owi\\_colorbar.png](#)
- [product-preview.html](#)
- [quick-look-12-owi.png](#)
- [quick-look-12-rvl.png](#)
- [rvl\\_colorbar.png](#)

#### support

- [s1-level-2-measurement.xsd](#)
- [s1-level-2.png.xsd](#)
- [s1-map-overlay.xsd](#)
- [s1-object-types.xsd](#)
- [s1-product-preview.xsd](#)

Figure 6-31 Example Product Preview ADS for L2 products



**Table 6-127 Contents of the Product Preview ADS**

Element	Description	Inclusion Criteria
Header Graphic	The Product Preview ADS should include a header graphic. This element is an image that is meaningful to or identifies the organisation that created the product or for which the product was created. The graphic may include any generally relevant imagery and more specific items such as company logos and copyright notices.	Optional
Product Name	The Product Preview ADS shall include a field which identifies the name of the product to which this ADS applies	Mandatory
Manifest	The Product Preview ADS shall include an accessible link to the product manifest file on the local file system.	Mandatory
Annotations	The Product Preview ADS shall include an accessible link to each and every annotation data set file within the product on the local file system.	Mandatory
Measurement	The Product Preview ADS shall include an accessible link to each and every measurement data set file within the product on the local file system.	Mandatory
Support	The Product Preview ADS should include an accessible link to each and every representation data set file (schema) within the product on the local file system.	Optional
Quick-look images	The Product Preview ADS shall include the Quick-look image to display as a reference for the product.	Optional

## **A XML SCHEMAS**

### **A1 SENTINEL-1 OBJECT TYPES SCHEMA**

Defines the primitive data types used by the Sentinel-1 product schemas

See attached file “s1-object-types.xsd”

### **A2 SENTINEL-1 L1 PRODUCT ANNOTATION SCHEMA**

Defines the Sentinel-1 L1 Product Annotation Data Set

See attached file “s1-level-1-product.xsd”

### **A3 SENTINEL-1 L1 CALIBRATION SCHEMA**

Defines the Sentinel-1 L1 Calibration Data Set

See attached file “s1-level-1-calibration.xsd”

### **A4 SENTINEL-1 L1 NOISE SCHEMA**

Defines the Sentinel-1 L1 Noise Data Set

See attached file “s1-level-1-noise.xsd”

### **A5 SENTINEL-1 L1 RFI SCHEMA**

Defines the Sentinel-1 L1 RFI Data Set

See attached file “s1-level-1-rfi.xsd”

### **A6 SENTINEL-1 SAFE SPECIALISATION SCHEMAS**

See attached schema files in the “xsd/” folder